



MERCURY
GO BOLDLY.™



**Operation
and
Maintenance
Manual**

8M0175491

920 eng



© 2020 Mercury Marine

V8 (200–300), V6 (175–225) CMS Mechanical

Welcome

You have selected one of the finest marine power packages available. It incorporates numerous design features to ensure operating ease and durability. With proper care and maintenance, you will enjoy using this product for many boating seasons. To ensure maximum performance and carefree use, we ask that you thoroughly read this manual.

The Operation and Maintenance Manual contains specific instructions for using and maintaining your product. Keep this manual with the product for ready reference whenever you are on the water.

Thank you for purchasing one of our products. We sincerely hope your boating will be pleasant.

Mercury Marine, Fond du Lac, Wisconsin, U.S.A.

Name / function:

Christopher D. Drees, President,
Mercury Marine



Read This Manual Thoroughly

IMPORTANT: If you do not understand any portion of this manual, contact your dealer. Your dealer can also provide a demonstration of actual starting and operating procedures.

Notice

Throughout this publication and on your power package, safety alerts labeled

WARNING and CAUTION (accompanied by the symbol ) , are used to alert you to special instructions concerning a particular service or operation that may be hazardous if performed incorrectly or carelessly. Observe these alerts carefully.

These safety alerts alone cannot eliminate the hazards that they signal. Strict compliance to these special instructions when performing the service, plus common sense operation, are major accident prevention measures.

WARNING

Indicates a hazardous situation which, if not avoided, could result in death or serious injury.

CAUTION

Indicates a hazardous situation which, if not avoided, could result in minor or moderate injury.

Additional alerts provide information that requires special attention:

NOTICE

Indicates a situation which, if not avoided, could result in engine or major component failure.

IMPORTANT: Identifies information essential to the successful completion of the task.

NOTE: Indicates information that helps in the understanding of a particular step or action.

IMPORTANT: The operator (driver) is responsible for the correct and safe operation of the boat, the equipment aboard, and the safety of all occupants aboard. We strongly recommend that the operator read this Operation and Maintenance Manual and thoroughly understand the operational instructions for the power package and all related accessories before the boat is used.

California Proposition 65



WARNING: This product can expose you to chemicals including gasoline engine exhaust, which is known to the State of California to cause cancer and birth defects or other reproductive harm. For more information go to www.P65Warnings.ca.gov.

Descriptions and specifications contained herein were in effect at the time this was approved for printing. Mercury Marine, whose policies are based on continuous improvement, reserves the right to discontinue models at any time or to change specifications or designs without notice and without incurring obligation.

Warranty Message

The product you have purchased comes with a **Mercury Marine Limited Warranty**. The terms of the warranty are set forth in the Warranty Manual, which can be accessed any time on the Mercury Marine website, at <http://www.mercurymarine.com/warranty-manual>. The Warranty Manual contains a description of what is covered, what is not covered, the duration of coverage, how to best obtain warranty coverage, **important disclaimers, limitations, and waivers**, and other related information. Please review this important information.

Mercury Marine products are designed and manufactured to comply with our own high quality standards, applicable industry standards and regulations, and certain emissions regulations. At Mercury Marine every engine is operated and tested before it is boxed for shipment to make sure that the product is ready for use. In addition, certain Mercury Marine products are tested in a controlled and monitored environment, for up to 10 hours of engine run time, in order to verify and make a record of compliance with applicable standards and regulations. All Mercury Marine product, sold as new, receives the applicable limited warranty coverage, whether the engine participated in one of the test programs described above or not.

Copyright and Trademark Information

© **MERCURY MARINE. All rights reserved. Reproduction in whole or in part without permission is prohibited.**

Alpha, Axis, Bravo One, Bravo Two, Bravo Three, Circle M with Waves Logo, GO BOLDLY, K-planes, Mariner, MerCathode, MerCruiser, Mercury, Mercury with Waves Logo, Mercury Marine, Mercury Precision Parts, Mercury Propellers, Mercury Racing, MotorGuide, OptiMax, Pro XS, Quicksilver, SeaCore, Skyhook, SmartCraft, Sport-Jet, Verado, VesselView, Zero Effort, Zeus, #1 On the Water and We're Driven to Win are registered trademarks of Brunswick Corporation. Mercury Product Protection is a registered service mark of Brunswick Corporation. All other marks are the property of their respective owners.

Identification Records

The serial numbers are the manufacturer's keys to numerous engineering details that apply to your Mercury Marine power package. When contacting Mercury Marine about service, **always specify model and serial numbers.**

Please record the following applicable information:

Outboard		
Engine Model and Horsepower		
Engine Serial Number		
Gear Ratio		
Propeller Number	Pitch	Diameter
Watercraft Identification Number (WIN) or Hull Identification Number (HIN)		Purchase Date
Boat Manufacturer	Boat Model	Length
Exhaust Gas Emissions Certification Number (Europe Only)		

General Information

Boater's Responsibilities.....	1
Before Operating Your Outboard.....	1
Boat Horsepower Capacity.....	1
High-Speed and High-Performance Boat Operation.....	2
Propeller Selection.....	2
Outboard Remote Control Models	4
Lanyard Stop Switch.....	5
Protecting People in the Water.....	7
Passenger Safety Message - Pontoon Boats and Deck Boats.....	8
Wave and Wake Jumping.....	9
Impact with Underwater Hazards.....	10
Exhaust Emissions.....	11
Selecting Accessories for Your Outboard.....	13
Safe Boating Recommendations.....	13
Recording Serial Number.....	16
Specification—V6 Models.....	17
Specification—V8 Models.....	23
Specifications—250R, 300R.....	29
Component Identification.....	32
Gearcase Identification.....	33

Transporting

Aquatic Invasive Species (AIS).....	35
Trailer Boat/Outboard.....	35

Fuel and Oil

Fuel Requirements.....	37
Fuel Additives.....	38
Low Permeation Fuel Hose Requirement	38
Fuel Demand Valve (FDV) Requirement.....	38
Engine Oil Recommendations—Standard, Pro XS, and Race (R) Models.....	39
Engine Oil Recommendations—SeaPro Models.....	40
Checking and Adding Engine Oil.....	40

Features and Controls

Adaptive Speed Control.....	44
Remote Control Features.....	44
Warning System.....	44
Power Trim and Tilt.....	47

Operation

Important Daily Inspection Before Each Use	51
Prestarting Check List.....	51
Operating in Freezing Temperatures.....	51
Operating in Saltwater or Polluted Water.....	52
Operating at High Elevations.....	53
Effects of Elevation and Weather on Performance.....	53
Setting Trim Angle while Running Engine at Idle Speed.....	54
Engine Break-in Procedure.....	54
Fuel Supply Module Priming Procedure.....	55
Starting the Engine.....	56
Gear Shifting.....	60
Stopping the Engine.....	60
Proper Outboard Tilt Positioning During Periods of Non-Use	61

Maintenance

Cleaning Care Recommendations.....	62
EPA Emissions Regulations.....	65
Inspection and Maintenance Schedule.....	66
Maintenance Schedule Decals.....	68
Flushing the Cooling System.....	73
Top Cowl Removal and Installation.....	73
Battery Inspection	75
Battery Cables and Clean Power Harness.....	76
Fuel System.....	78
Corrosion Control Anode.....	80
Propeller Replacement.....	81
Propeller Replacement—31.75 mm (1-1/4 in.) Diameter Propeller Shaft.....	86
Spark Plug Inspection and Replacement.....	88
Fuses.....	90
Alternator Drive Belt	92
Lubrication Points.....	92
Checking Power Trim Fluid.....	94
Checking Hydraulic Steering Fluid.....	95
Checking Power Steering Fluid.....	96
Changing Engine Oil and Filter.....	96
Checking Engine Oil Level.....	101
Exhaust Water Strainer Inspection.....	102
Gearcase Lubricant.....	104

Storage

Storage Preparation.....	110
Protecting External Outboard Components.....	110
Protecting Internal Engine Components.....	111
Gearcase.....	111
Positioning Outboard for Storage.....	111
Battery Storage.....	111

Troubleshooting

Starter Motor Will Not Crank the Engine.....	112
Engine Will Not Start.....	112
Engine Runs Erratically.....	112
Performance Loss.....	113
Battery Will Not Hold Charge.....	113

Owner Service Assistance

Service Assistance.....	114
Ordering Literature.....	116

Maintenance Log

Maintenance Log.....	118
----------------------	-----

GENERAL INFORMATION

Boater's Responsibilities

The operator (driver) is responsible for the correct and safe operation of the boat and the safety of its occupants and general public. It is strongly recommended that each operator read and understand this entire manual before operating the outboard.

Be sure that at least one additional person onboard is instructed in the basics of starting and operating the outboard and boat handling in case the driver is unable to operate the boat.

Before Operating Your Outboard

Read this manual carefully. Learn how to operate your outboard properly. If you have any questions, contact your dealer.

Safety and operating information that is practiced, along with using good common sense, can help prevent personal injury and product damage.

This manual as well as safety labels posted on the outboard use the following safety alerts to draw your attention to special safety instructions that should be followed.

WARNING

Indicates a hazardous situation which, if not avoided, could result in death or serious injury.

CAUTION

Indicates a hazardous situation which, if not avoided, could result in minor or moderate injury.

NOTICE

Indicates a situation which, if not avoided, could result in engine or major component failure.

Boat Horsepower Capacity

WARNING

Exceeding the boat's maximum horsepower rating can cause serious injury or death. Overpowering the boat can affect boat control and flotation characteristics or break the transom. Do not install an engine that exceeds the boat's maximum power rating.

GENERAL INFORMATION

Do not overpower or overload your boat. Most boats will carry a required capacity plate indicating the maximum acceptable power and load as determined by the manufacturer following certain federal guidelines. If in doubt, contact your dealer or the boat manufacturer.

U.S. COAST GUARD CAPACITY	
MAXIMUM HORSEPOWER	XXX
MAXIMUM PERSON CAPACITY (POUNDS)	XXX
MAXIMUM WEIGHT CAPACITY	XXX

26777

High-Speed and High-Performance Boat Operation

If your outboard is to be used on a high-speed or high-performance boat with which you are unfamiliar, we recommend that you do not operate it at its high-speed capability without first requesting an initial orientation and familiarization demonstration ride with your dealer or an operator experienced with your boat/outboard combination. For additional information, obtain a copy of our **Hi-Performance Boat Operation** booklet from your dealer, distributor, or Mercury Marine.

Propeller Selection

The propeller on your outboard is one of the most important components in the propulsion system. An improper propeller choice can significantly affect the performance of your boat and could result in damage to the outboard engine.

When choosing a propeller, a full selection of aluminum and stainless steel propellers specifically designed for your outboard are available through Mercury Marine. To view the entire product offering and find the correct propeller that is best suited for your application, visit www.mercmarinepropellers.com or see your local authorized Mercury dealer.

SELECTING THE CORRECT PROPELLER

An accurate tachometer for measuring engine speed is important in choosing the correct propeller.

Choose a propeller for your boating application that will allow the engine to operate within the specified full throttle operating range. When operating the boat at full throttle under normal load conditions, the engine RPM should be in the upper half of the recommended full throttle RPM range. Refer to **Specifications**. If engine RPM is above that range, select a propeller of increased pitch in order to reduce engine RPM. If engine RPM is below the recommended range, select a propeller of reduced pitch to increase engine RPM.

GENERAL INFORMATION

IMPORTANT: To ensure proper fit, and performance, Mercury Marine recommends the use of Mercury or Quicksilver branded propellers and mounting hardware.

Propellers are designated by the diameter, pitch, number of blades, and material. The diameter and pitch are stamped (cast) into the side or the end of the propeller hub. The first number represents the diameter of the propeller and the second number represents the pitch. For example, 14x19 represents a propeller with a 14 inch diameter and 19 inches of pitch.

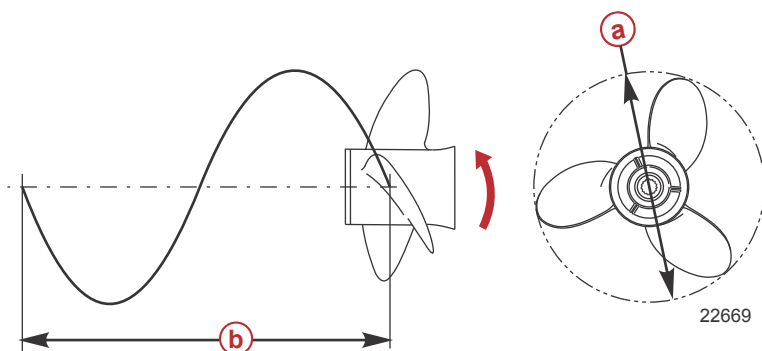

- a** - Diameter
- b** - Pitch - Travel during one revolution

The following are some propeller basics that will help you determine the correct propeller for your boating application.

Diameter - The diameter is the distance across the imaginary circle that is made when the propeller rotates. The correct diameter for each propeller has been predetermined for the design of your outboard. However, when more than one diameter is available for the same pitch, use a larger diameter for heavy boat applications and a smaller diameter for lighter applications.

Pitch - The pitch is the theoretical distance, in inches, that a propeller travels forward during one revolution. Pitch can be thought of similar to gears in a car. The lower the gear, the faster the car will accelerate, but with lower overall top speed. Likewise, a lower pitch propeller will accelerate quickly, but top-end speed will be reduced. The higher the propeller pitch the faster the boat will usually go; though typically slowing acceleration.

Determining the correct pitch size - First, check the full throttle RPM under normal load condition. If the full throttle RPM is within the recommended range, select a replacement or upgrade propeller with the same pitch as the current propeller.

- Adding 1 inch of pitch will reduce the full throttle RPM by 150 to 200
- Subtracting 1 inch of pitch will increase full throttle RPM by 150 to 200

GENERAL INFORMATION

- Upgrading from a 3-blade propeller to a 4-blade propeller will generally decrease full throttle RPM by 50 to 100

IMPORTANT: Avoid damage to the engine. Never use a propeller that allows the engine to exceed the recommended full throttle RPM range when under normal full throttle operation.

PROPELLER MATERIAL

Most propellers manufactured by Mercury Marine are made from either aluminum or stainless steel. Aluminum is suitable for general purpose use and is standard equipment on many new boats. Stainless steel is over five times more durable than aluminum and typically provides performance gains in acceleration and top end speed due to design efficiencies. Stainless steel propellers also come in a larger variety of sizes and styles that allow you to dial in the ultimate performance for your boat.

3 BLADE VS. 4 BLADE

Available in many sizes of both aluminum and stainless, 3 and 4-blade propellers have unique performance characteristics. In general, 3-blade propellers offer good all around performance and higher top speed than 4-blade propellers. However, 4-blade propellers are usually faster to plane and more efficient at cruising speeds, but lack the top end speed of a 3-blade propeller.

Outboard Remote Control Models

The remote control connected to your outboard must be equipped with a start in neutral only protection device. This prevents the engine from starting when the shift is actuated in any position other than neutral.

▲ WARNING

Starting the engine with the drive in gear can cause serious injury or death. Never operate a boat that does not have a neutral-safety-protection device.



GENERAL INFORMATION

Lanyard Stop Switch

The purpose of a lanyard stop switch is to turn off the engine when the operator moves far enough away from the operator's position (as in accidental ejection from the operator's position) to activate the switch. Tiller handle outboards and some remote control units are equipped with a lanyard stop switch. A lanyard stop switch can be installed as an accessory - generally on the dashboard or side adjacent to the operator's position.

A decal near the lanyard stop switch is a visual reminder for the operator to attach the lanyard to their personal flotation device (PFD) or wrist.

The lanyard cord is usually 122–152 cm (4–5 feet) in length when stretched out, with an element on one end made to be inserted into the switch and a clip on the other end for attaching to the operator's PFD or wrist. The lanyard is coiled to make its at-rest condition as short as possible to minimize the likelihood of lanyard entanglement with nearby objects. Its stretched-out length is made to minimize the likelihood of accidental activation should the operator choose to move around in an area close to the normal operator's position. If it is desired to have a shorter lanyard, wrap the lanyard around the operator's wrist or leg, or tie a knot in the lanyard.

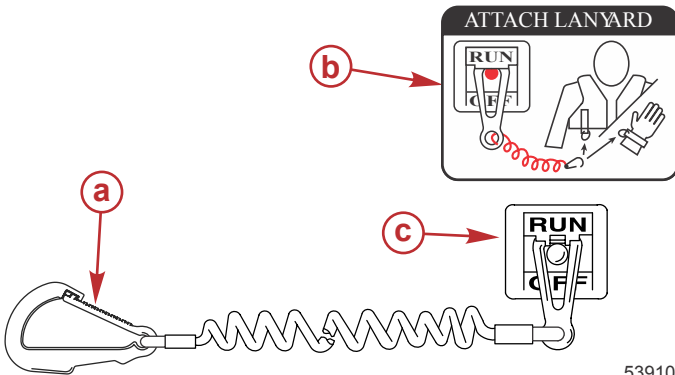

53910

- a** - Lanyard cord clip
- b** - Lanyard decal
- c** - Lanyard stop switch

Read the following Safety Information before proceeding.

GENERAL INFORMATION

Important Safety Information: The purpose of a lanyard stop switch is to stop the engine when the operator moves far enough away from the operator's position to activate the switch. This would occur if the operator accidentally falls overboard or moves within the boat a sufficient distance from the operator's position. Falling overboard and accidental ejections are more likely to occur in certain types of boats such as low sided inflatables, bass boats, high performance boats, and light, sensitive handling fishing boats operated by a hand tiller. Falling overboard and accidental ejections are also likely to occur as a result of poor operating practices such as sitting on the back of the seat or gunwale at planing speeds, standing at planing speeds, sitting on elevated fishing boat decks, operating at planing speeds in shallow or obstacle infested waters, releasing your grip on a steering wheel or tiller handle that is pulling in one direction, drinking alcohol or consuming drugs, or daring high speed boat maneuvers.

While activation of the lanyard stop switch will stop the engine immediately, a boat will continue to coast for some distance depending upon the velocity and degree of any turn at shut down. However, the boat will not complete a full circle. While the boat is coasting, it can cause injury to anyone in the boat's path as seriously as the boat would when under power.

We strongly recommend that other occupants be instructed on proper starting and operating procedures should they be required to operate the engine in an emergency (if the operator is accidentally ejected).

▲ WARNING

If the operator falls out of the boat, stop the engine immediately to reduce the possibility of serious injury or death from being struck by the boat. Always properly connect the operator to the stop switch using a lanyard.

▲ WARNING

Avoid serious injury or death from deceleration forces resulting from accidental or unintended stop switch activation. The boat operator should never leave the operator's station without first disconnecting the stop switch lanyard from the operator.

Accidental or unintended activation of the switch during normal operation is also a possibility. This could cause any, or all, of the following potentially hazardous situations:

- Occupants could be thrown forward due to unexpected loss of forward motion - a particular concern for passengers in the front of the boat who could be ejected over the bow and possibly struck by the gearcase or propeller.
- Loss of power and directional control in heavy seas, strong current, or high winds.
- Loss of control when docking.

GENERAL INFORMATION

KEEP THE LANYARD STOP SWITCH AND LANYARD CORD IN GOOD OPERATING CONDITION

Before each use, check to ensure the lanyard stop switch works properly. Start the engine and stop it by pulling the lanyard cord. If the engine does not stop, have the switch repaired before operating the boat.

Before each use, visually inspect the lanyard cord to ensure it is in good working condition and that there are no breaks, cuts, or wear to the cord. Check that the clips on the ends of the cord are in good condition. Replace any damaged or worn lanyard cords.

Protecting People in the Water

WHILE YOU ARE CRUISING

It is very difficult for a person standing or floating in the water to take quick action to avoid a boat heading in his/her direction, even at slow speed.



Always slow down and exercise extreme caution any time you are boating in an area where there might be people in the water.

Whenever a boat is moving (coasting) and the outboard gear shift is in neutral position, there is sufficient force by the water on the propeller to cause the propeller to rotate. This neutral propeller rotation can cause serious injury.

WHILE THE BOAT IS STATIONARY

▲ WARNING

A spinning propeller, a moving boat, or any solid device attached to the boat can cause serious injury or death to swimmers. Stop the engine immediately whenever anyone in the water is near your boat.

Shift the outboard into neutral and shut off the engine before allowing people to swim or be in the water near your boat.

GENERAL INFORMATION

Passenger Safety Message - Pontoon Boats and Deck Boats

Whenever the boat is in motion, observe the location of all passengers. Do not allow any passengers to stand or use seats other than those designated for traveling faster than idle speed. A sudden reduction in boat speed, such as plunging into a large wave or wake, a sudden throttle reduction, or a sharp change of boat direction, could throw them over the front of the boat. Falling over the front of the boat between the two pontoons will position them to be run over by the outboard.

BOATS HAVING AN OPEN FRONT DECK

No one should ever be on the deck in front of the fence while the boat is in motion. Keep all passengers behind the front fence or enclosure.

Persons on the front deck could easily be thrown overboard or persons dangling their feet over the front edge could get their legs caught by a wave and pulled into the water.

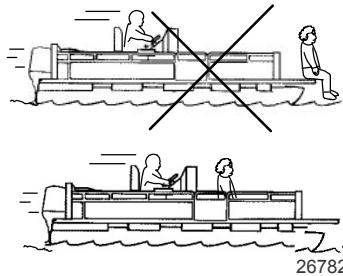

▲ WARNING

Sitting or standing in an area of the boat not designed for passengers at speeds above idle can cause serious injury or death. Stay back from the front end of deck boats or raised platforms and remain seated while the boat is in motion.

BOATS WITH FRONT MOUNTED, RAISED PEDESTAL FISHING SEATS

Elevated fishing seats are not intended for use when the boat is traveling faster than idle or trolling speed. Sit only in seats designated for traveling at faster speeds.

GENERAL INFORMATION

Any unexpected, sudden reduction in boat speed could result in the elevated passenger falling over the front of the boat.

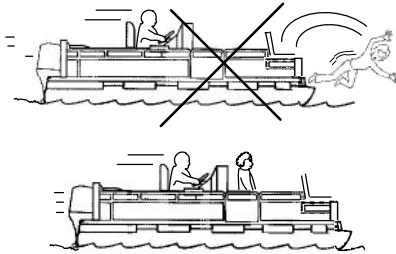

Wave and Wake Jumping

Operating recreational boats over waves and wake is a natural part of boating. However, when this activity is done with sufficient speed to force the boat hull partially or completely out of the water, certain hazards arise, particularly when the boat enters the water.

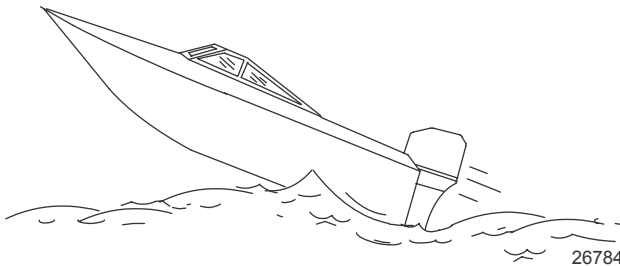

The primary concern is the boat changing direction while in the midst of the jump. In such case, the landing may cause the boat to veer violently in a new direction. Such a sharp change in direction can cause occupants to be thrown out of their seats, or out of the boat.

▲ WARNING

Wave or wake jumping can cause serious injury or death from occupants being thrown within or out of the boat. Avoid wave or wake jumping whenever possible.

There is another less common hazardous result from allowing your boat to launch off a wave or wake. If the bow of your boat pitches down far enough while airborne, upon water contact it may penetrate under the water surface and submarine for an instant. This will bring the boat to a nearly instantaneous stop and can send the occupants flying forward. The boat may also steer sharply to one side.

GENERAL INFORMATION

Impact with Underwater Hazards

Your outboard is equipped with a hydraulic trim and tilt system that also contains a shock absorbing feature. This feature helps the outboard withstand damage in the case of impact with an underwater object at low to moderate speeds. At higher speeds, the force of the impact may exceed the system's ability to absorb the energy of the impact and cause serious product damage.

No impact protection exists while in reverse. Use extreme caution when operating in reverse to avoid striking underwater objects.

Reduce speed and proceed with caution whenever you drive a boat in shallow water areas or in areas where you suspect underwater obstacles may exist that could be struck by the outboard or the boat bottom. **The most significant action you can take to help reduce injury or impact damage from striking a floating or underwater object is to control the boat speed. Under these conditions, boat speed should be kept to the minimum planing speed, typically 24 to 40 km/h (15 to 25 mph).**

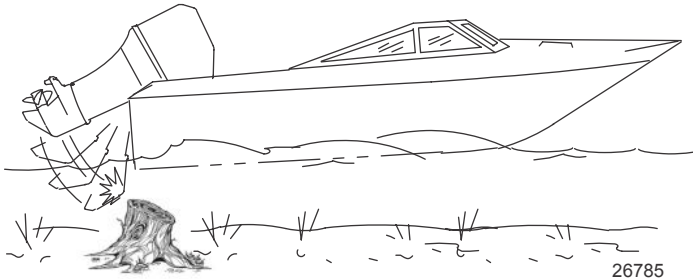

⚠ WARNING

Avoid serious injury or death from all or part of an outboard or drive unit coming into the boat after striking a floating or underwater object. When operating in waters where objects may be at the surface or just under the surface of the water, reduce your speed and keep a vigilant lookout.

Examples of objects that can cause engine damage are dredging pipes, bridge supports, wing dams, trees, stumps, and rocks.

Striking a floating or underwater object could result in any of an infinite number of situations. Some of these situations could yield the following:

- Part of the outboard or the entire outboard could break loose and fly into the boat.
- The boat could move suddenly in a new direction. A sharp change in direction can cause occupants to be thrown out of their seats or out of the boat.
- The boat's speed could rapidly reduce. This will cause occupants to be thrown forward or even out of the boat.

GENERAL INFORMATION

- The outboard or boat could sustain impact damage.

After striking a submerged object, stop the engine as soon as possible and inspect it for any broken or loose parts. If damage is present or suspected, the outboard should be taken to an authorized dealer for a thorough inspection and necessary repair.

The boat should also be checked for any hull fractures, transom fractures, or water leaks. If water leaks are discovered after an impact, immediately activate the bilge pump.

Operating a damaged outboard could cause additional damage to other parts of the outboard or could affect control of the boat. If continued running is necessary, do so at greatly reduced speeds.

WARNING

Operating a boat or engine with impact damage can result in product damage, serious injury, or death. If the vessel experiences any form of impact, have an authorized Mercury Marine dealer inspect and repair the vessel or power package.

Exhaust Emissions

BE ALERT TO CARBON MONOXIDE POISONING

Carbon monoxide (CO) is a deadly gas that is present in the exhaust fumes of all internal combustion engines, including the engines that propel boats, and the generators that power boat accessories. By itself, CO is odorless, colorless, and tasteless, but if you can smell or taste engine exhaust, you are inhaling CO.

Early symptoms of carbon monoxide poisoning, which are similar to the symptoms of seasickness and intoxication, include headache, dizziness, drowsiness, and nausea.

WARNING

Inhaling engine exhaust gases can result in carbon monoxide poisoning, which can lead to unconsciousness, brain damage, or death. Avoid exposure to carbon monoxide.

Stay clear from exhaust areas when engine is running. Keep the boat well-ventilated while at rest or underway.

GENERAL INFORMATION

STAY CLEAR OF EXHAUST AREAS

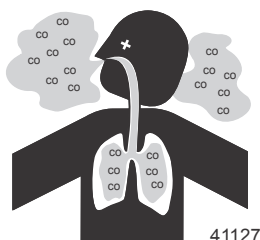

Engine exhaust gases contain harmful carbon monoxide. Avoid areas of concentrated engine exhaust gases. When engines are running, keep swimmers away from the boat, and do not sit, lie, or stand on swim platforms or boarding ladders. While underway, do not allow passengers to be positioned immediately behind the boat (platform dragging, teak/body surfing). This dangerous practice not only places a person in an area of high engine exhaust concentration, but also subjects them to the possibility of injury from the boat propeller.

GOOD VENTILATION

Ventilate the passenger area, open side curtains or forward hatches to remove fumes.

Example of desired air flow through the boat:

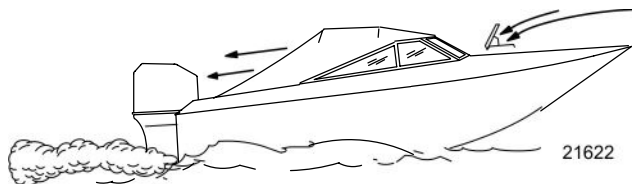

POOR VENTILATION

Under certain running and/or wind conditions, permanently enclosed or canvas enclosed cabins or cockpits with insufficient ventilation may draw in carbon monoxide. Install one or more carbon monoxide detectors in your boat.

Although the occurrence is rare, on a very calm day, swimmers and passengers in an open area of a stationary boat that contains, or is near, a running engine may be exposed to a hazardous level of carbon monoxide.

GENERAL INFORMATION

1. Examples of poor ventilation while the boat is stationary:

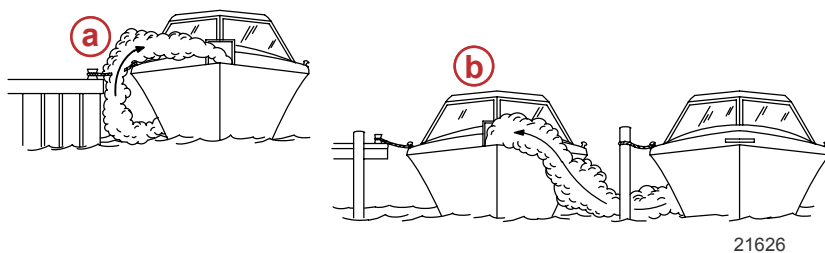

- a** - Operating the engine when the boat is moored in a confined space
- b** - Mooring close to another boat that has its engine operating

2. Examples of poor ventilation while the boat is moving:

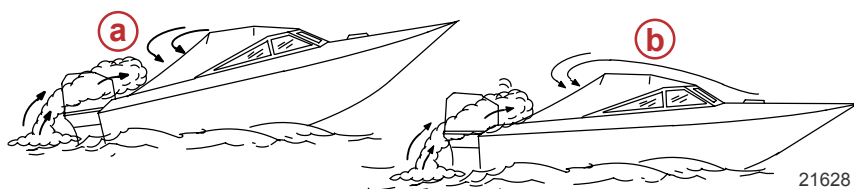

- a** - Operating the boat with the trim angle of the bow too high
- b** - Operating the boat with no forward hatches open (station wagon effect)

Selecting Accessories for Your Outboard

Genuine Mercury Precision or Quicksilver Accessories have been specifically designed and tested for your outboard. These accessories are available from Mercury Marine dealers.

IMPORTANT: Check with your dealer before installing accessories. The misuse of approved accessories or the use of nonapproved accessories can damage the product.

Some accessories not manufactured or sold by Mercury Marine are not designed to be safely used with your power package and may void warranty. Acquire and read the installation and operation manuals for each selected accessory.

Safe Boating Recommendations

To safely enjoy the waterways, familiarize yourself with local and all other governmental boating regulations and restrictions and consider the following suggestions.

Know and obey all nautical rules and laws of the waterways.

GENERAL INFORMATION

- We recommend that all powerboat operators complete a boating safety course. In the U.S., the U.S. Coast Guard Auxiliary, the Power Squadron, the Red Cross, and your state or provincial boating law enforcement agency provide courses. For more information in the U.S., call the Boat U.S. Foundation at 1-800-336-BOAT (2628).

Perform safety checks and required maintenance.

- Follow a regular schedule and ensure that all repairs are properly made.

Check safety equipment onboard.

- Here are some suggestions of the types of safety equipment to carry when boating:
 - Approved fire extinguishers
 - Signal devices: flashlight, rockets or flares, flag, and whistle or horn
 - Tools necessary for minor repairs
 - Anchor and extra anchor line
 - Manual bilge pump and extra drain plugs
 - Drinking water
 - Radio
 - Paddle or oar
 - Spare propeller, thrust hubs, and an appropriate wrench
 - First aid kit and instructions
 - Waterproof storage containers
 - Spare operating equipment, batteries, bulbs, and fuses
 - Compass and map or chart of the area
 - Personal flotation device (one per person onboard)

Watch for signs of weather change and avoid foul weather and rough-sea boating.

Tell someone where you are going and when you expect to return.

Passenger boarding.

- Stop the engine whenever passengers are boarding, unloading, or are near the back (stern) of the boat. Shifting the drive unit into neutral is not sufficient.

Use personal flotation devices.

- Federal law requires that there be a U.S. Coast Guard-approved life jacket (personal flotation device), correctly sized and readily accessible for every person onboard, plus a throwable cushion or ring. We strongly advise that everyone wear a life jacket at all times while in the boat.

Prepare other boat operators.

GENERAL INFORMATION

- Instruct at least one person onboard in the basics of starting and operating the engine and boat handling in case the driver becomes disabled or falls overboard.

Do not overload your boat.

- Most boats are rated and certified for maximum load (weight) capacities (refer to your boat's capacity plate). Know your boat's operating and loading limitations. Know if your boat will float if it is full of water. When in doubt, contact your authorized Mercury Marine dealer or the boat manufacturer.

Ensure that everyone in the boat is properly seated.

- Do not allow anyone to sit or ride on any part of the boat that was not intended for such use. This includes the backs of seats, gunwales, transom, bow, decks, raised fishing seats, and any rotating fishing seat. Passengers should not sit or ride anywhere that sudden unexpected acceleration, sudden stopping, unexpected loss of boat control, or sudden boat movement could cause a person to be thrown overboard or into the boat. Ensure that all passengers have a proper seat and are in it before any boat movement.

Never operate a boat while under the influence of alcohol or drugs. It is the law.

- Alcohol or drugs can impair your judgment and greatly reduce your ability to react quickly.

Know your boating area and avoid hazardous locations.

Be alert.

- The operator of the boat is responsible by law to maintain a proper lookout by sight and hearing. The operator must have an unobstructed view particularly to the front. No passengers, load, or fishing seats should block the operator's view when the boat is above idle or planing transition speed. Watch out for others, the water, and your wake.

Never drive your boat directly behind a water-skier.

- Your boat traveling at 40 km/h (25 mph) will overtake a fallen skier who is 61 m (200 ft) in front of you in five seconds.

Watch fallen skiers.

- When using your boat for waterskiing or similar activities, always keep a fallen or down skier on the operator's side of the boat while returning to attend to the skier. The operator should always have the down skier in sight and never back up to the skier or anyone in the water.

Report accidents.

GENERAL INFORMATION

- Boat operators are required by law to file a boating accident report with their state boating law enforcement agency when their boat is involved in certain boating accidents. A boating accident must be reported if 1) there is loss of life or probable loss of life, 2) there is personal injury requiring medical treatment beyond first aid, 3) there is damage to boats or other property where the damage value exceeds \$500.00, or 4) there is complete loss of the boat. Seek further assistance from local law enforcement.

Recording Serial Number

It is important to record this number for future reference. The serial number is located on the outboard, as shown.

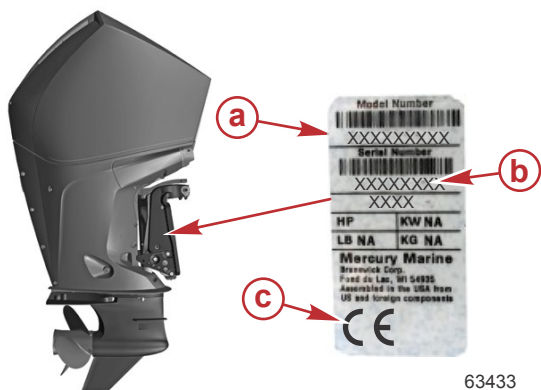

- a** - Model designation
- b** - Serial number
- c** - Certified Europe insignia (as applicable)

GENERAL INFORMATION

Specification—V6 Models

V6 FOURSTROKE MODELS

Attribute		175	200	225
Horsepower		175	200	225
Kilowatts		129	147	165
Full throttle RPM range		5000–5800		5200–6000
Idle RPM in neutral gear*		600		
Idle charge compensation**		600–725		
Troll control RPM limit		550–1000		
Number of cylinders		6		
Displacement		3.4 Liter 3,432 cc (209.4 cid)		
Cylinder bore		92 mm (3.62 in.)		
Stroke		86 mm (3.38 in.)		
Spark plug		NGK LKAR7C-9		
Spark plug gap		0.9 mm (0.035 in.)		
Spark plug hex size		14 mm		
Gearcase type		122 mm (4.8 in.)		
Gearcase capacity***	Right-hand	710 mL (24.0 fl oz)		
	Left-hand	810 mL (27.4 fl oz)		
Gear ratio		1.85:1		
Recommended gasoline		Refer to Fuel and Oil		
Recommended oil		Refer to Fuel and Oil		
Engine oil capacity with oil filter replacement		6.6 Liter (7.0 US qt)		
Required battery type		12-volt absorbed glass mat (AGM) battery		
Battery type****	USA (SAE)	800 minimum marine cranking amps (MCA) with a minimum reserve capacity of 135 RC25 rating		
	International (EN)	975 minimum cold cranking amps (CCA) with a minimum 65 amp hour (Ah)		

GENERAL INFORMATION

*Engine at normal operation temperature.

**The idle charge compensation may automatically increase the engine speed up to 725 RPM to compensate for a low battery charge condition. The increased idle RPM will charge the battery at a higher rate. Activating troll control (optional accessory) will override the idle charge compensation feature.

***Early model right-hand 4.8 in. gearcase bearing carriers may have the vent located at the 3 o'clock position, requiring a slightly lower volume of gear lubrication.

****Battery manufacturers may rate and test their batteries to different standards. MCA, CCA, Ah, and reserve capacity (RC) are the ratings recognized by Mercury Marine. Manufacturers that use standards different than these, such as equivalent MCA, do not meet Mercury Marine battery requirements.

GENERAL INFORMATION

V6 PRO XS MODELS

Attribute		175
Horsepower		175
Kilowatts		129
Full throttle RPM range		5400–6000
Idle RPM in neutral gear*		600
Idle charge compensation**		600–725
Troll control RPM limit		550–1000
Number of cylinders		6
Displacement		3.4 L 3,432 cc (209.4 cid)
Cylinder bore		92 mm (3.62 in.)
Stroke		86 mm (3.38 in.)
Spark plug		NGK LKAR7C-9
Spark plug gap		0.9 mm (0.035 in.)
Spark plug hex size		14 mm
Gearcase type		122 mm (4.8 in.)
Gearcase capacity***	Right-hand	710 mL (24.0 fl oz)
	Left-hand	810 mL (27.4 fl oz)
Gear ratio		1.85:1
Recommended gasoline		Refer to Fuel and Oil
Recommended oil		Refer to Fuel and Oil
Engine oil capacity with oil filter replacement		6.6 L (7.0 US qt)
Required battery type		12-volt absorbed glass mat (AGM) battery
Battery rating****	USA (SAE)	800 minimum marine cranking amps (MCA) with a minimum reserve capacity of 135 RC25 rating
	International (EN)	975 minimum cold cranking amps (CCA) with a minimum 65 amp hour (Ah)

GENERAL INFORMATION

*Engine at normal operation temperature.

**The idle charge compensation may automatically increase the engine speed up to 725 RPM to compensate for a low battery charge condition. The increased idle RPM will charge the battery at a higher rate. Activating troll control (optional accessory) will override the idle charge compensation feature.

***Early model 4.8 in. gearcase bearing carriers may have the vent located at the 3 o'clock position, requiring a slightly lower volume of gear lubricant.

****Battery manufacturers may rate and test their batteries to different standards. MCA, CCA, Ah, and reserve capacity (RC) are the ratings recognized by Mercury Marine. Manufacturers that use standards different than these, such as equivalent MCA, do not meet Mercury Marine battery requirements.

GENERAL INFORMATION

SEAPRO V6 MODELS

Attribute		200 SeaPro
Horsepower		200
Kilowatts		147
Full throttle RPM range		4600–5400
Idle RPM in neutral gear*		600
Idle charge compensation**		600–725
Troll control RPM limit		550–1000
Number of cylinders		6
Displacement		3.4 Liter 3,432 cc (209.4 cid)
Cylinder bore		92 mm (3.62 in.)
Stroke		86 mm (3.38 in.)
Spark plug		NGK LKAR7C-9
Spark plug gap		0.9 mm (0.035 in.)
Spark plug hex size		14 mm
Gearcase type—SeaPro		137 mm (5.4 in.)
Gearcase capacity	Right-hand	980 mL (33.1 fl oz)
	Left-hand	
Gear ratio		1.85:1
Recommended gasoline		Refer to Fuel and Oil
Recommended oil		Refer to Fuel and Oil
Engine oil capacity with oil filter replacement		6.6 Liter (7.0 US qt)
Required battery type		12-volt absorbed glass mat (AGM) battery
Battery type***	USA (SAE)	800 minimum marine cranking amps (MCA) with a minimum reserve capacity of 135 RC25 rating
	International (EN)	975 minimum cold cranking amps (CCA) with a minimum 65 amp hour (Ah)

GENERAL INFORMATION

*Engine at normal operation temperature.

**The idle charge compensation may automatically increase the engine speed up to 725 RPM to compensate for a low battery charge condition. The increased idle RPM will charge the battery at a higher rate. Activating troll control (optional accessory) will override the idle charge compensation feature.

***Battery manufacturers may rate and test their batteries to different standards. MCA, CCA, Ah, and reserve capacity (RC) are the ratings recognized by Mercury Marine. Manufacturers that use standards different than these, such as equivalent MCA, do not meet Mercury Marine battery requirements.

GENERAL INFORMATION

Specification—V8 Models

V8 FOURSTROKE MODELS

Attribute		250	300
Horsepower		250	300
Kilowatts		184	221
Full throttle RPM range		5200–6000	
Idle RPM in neutral gear*		600	
Idle charge compensation**		600–725	
Troll control RPM limit		550–1000	
Number of cylinders		8	
Displacement		4.6 L 4,576 cc (279.2 cid)	
Cylinder bore		92 mm (3.62 in.)	
Stroke		86 mm (3.38 in.)	
Spark plug		NGK LKAR7C-9	
Spark plug gap		0.9 mm (0.035 in.)	
Spark plug hex size		14 mm	
Gearcase type		137 mm (5.4 in.)	
Gear ratio		1.75:1 1.85:1	
Gearcase capacity	Right-hand	720 mL (24.4 fl oz)	
	Left-hand	680 mL (23.0 fl oz)	
Recommended gasoline		Refer to Fuel and Oil	
Recommended oil		Refer to Fuel and Oil	
Engine oil capacity with oil filter replacement		6.6 Liter (7.0 US qt)	
Required battery type		12-volt absorbed glass mat (AGM) battery	
Battery rating***	USA (SAE)	800 minimum marine cranking amps (MCA) with a minimum reserve capacity of 135 RC25 rating	
	International (EN)	975 minimum cold cranking amps (CCA) with a minimum 65 amp hour (Ah)	

GENERAL INFORMATION

*Engine at normal operation temperature.

**The idle charge compensation may automatically increase the engine speed up to 725 RPM to compensate for a low battery charge condition. The increased idle RPM will charge the battery at a higher rate. Activating trol control (optional accessory) will override the idle charge compensation feature.

***Battery manufacturers may rate and test their batteries to different standards. MCA, CCA, Ah, and reserve capacity (RC) are the ratings recognized by Mercury Marine. Manufacturers that use standards different than these, such as equivalent MCA, do not meet Mercury Marine battery requirements.

GENERAL INFORMATION

V8 PRO XS MODELS

Attribute		200	225	250	300
Horsepower		200	225	250	300
Kilowatts		147	165	184	221
Full throttle RPM range		5600–6200			
Idle RPM in neutral gear*		600			
Idle charge compensation**		600–725			
Troll control RPM limit		550–1000			
Number of cylinders		8			
Displacement		4.6 L 4,576 cc (279.2 cid)			
Cylinder bore		92 mm (3.62 in.)			
Stroke		86 mm (3.38 in.)			
Spark plug		NGK LKAR7C-9			
Spark plug gap		0.9 mm (0.035 in.)			
Spark plug hex size		14 mm			
Torque Master ratio		1.75:1			
122 mm (4.8 in.) ratio		1.85:1			
137 mm (5.4 in.) ratio		1.75:1			
Gearcase capacity	Torque Master	520 mL (17.5 fl oz)			
	122 mm (4.8 in.) RH***	710 mL (24.0 fl oz)			
	137 mm (5.4 in.) RH	720 mL (24.4 fl oz)			
	137 mm (5.4 in.) LH	680 mL (23.0 fl oz)			
Recommended gasoline		Refer to Fuel and Oil			
Recommended oil		Refer to Fuel and Oil			
Engine oil capacity with oil filter replacement		6.6 L (7.0 US qt)			
Required battery type		12-volt absorbed glass mat (AGM) battery			
Battery rating****	USA (SAE)	800 minimum marine cranking amps (MCA) with a minimum reserve capacity of 135 RC25 rating			
	International (EN)	975 minimum cold cranking amps (CCA) with a minimum 65 amp hour (Ah)			

GENERAL INFORMATION

*Engine at normal operation temperature.

**The idle charge compensation may automatically increase the engine speed up to 725 RPM to compensate for a low battery charge condition. The increased idle RPM will charge the battery at a higher rate. Activating troll control (optional accessory) will override the idle charge compensation feature.

***Early model 4.8 in. gearcase bearing carriers may have the lubricant level plug located at the 3 o'clock position, requiring a slightly lower volume of gear lubricant.

****Battery manufacturers may rate and test their batteries to different standards. MCA, CCA, Ah, and reserve capacity (RC) are the ratings recognized by Mercury Marine. Manufacturers that use standards different than these, such as equivalent MCA, do not meet Mercury Marine battery requirements.

GENERAL INFORMATION

SEAPRO V8 MODELS

Attribute		225 SeaPro	250 SeaPro	300 SeaPro
Horsepower		225	250	300
Kilowatts		165	184	221
Full throttle RPM range		4800–5600		
Idle RPM in neutral gear*		600		
Idle charge compensation**		600–725		
Troll control RPM limit		550–1000		
Number of cylinders		8		
Displacement		4.6 Liter 4,576 cc (279.2 cid)		
Cylinder bore		92 mm (3.62 in.)		
Stroke		86 mm (3.38 in.)		
Spark plug		NGK LKAR7C-9		
Spark plug gap		0.9 mm (0.035 in.)		
Spark plug hex size		14 mm		
Gearcase type—SeaPro		137 mm (5.4 in.)		
Gear ratio	Right-hand	1.75:1		
	Left-hand			
Gearcase capacity	Right-hand	980 mL (33.1 fl oz)		
	Left-hand			
Recommended gasoline		Refer to Fuel and Oil		
Recommended oil		Refer to Fuel and Oil		
Engine oil capacity with oil filter replacement		6.6 Liter (7.0 US qt)		
Required battery type		12-volt absorbed glass mat (AGM) battery		
Battery type***	USA (SAE)	800 minimum marine cranking amps (MCA) with a minimum reserve capacity of 135 RC25 rating		
	International (EN)	975 minimum cold cranking amps (CCA) with a minimum 65 amp hour (Ah)		

GENERAL INFORMATION

*Engine at normal operation temperature.

**The idle charge compensation may automatically increase the engine speed up to 725 RPM to compensate for a low battery charge condition. The increased idle RPM will charge the battery at a higher rate. Activating trol control (optional accessory) will override the idle charge compensation feature.

***Battery manufacturers may rate and test their batteries to different standards. MCA, CCA, Ah, and reserve capacity (RC) are the ratings recognized by Mercury Marine. Manufacturers that use standards different than these, such as equivalent MCA, do not meet Mercury Marine battery requirements.

GENERAL INFORMATION

Specifications—250R, 300R

250R MODELS

Attribute		250R
Horsepower		250
Kilowatts		184
Full throttle RPM range		5600–6200
Idle RPM in neutral gear*		600
Idle charge compensation**		600–725
Troll control RPM limit		550–1000
Number of cylinders		8
Displacement		4.6 Liter 4,576 cc (279.2 cid)
Cylinder bore		92 mm (3.62 in.)
Stroke		86 mm (3.38 in.)
Spark plug		NGK LKAR7C-9
Spark plug gap		0.9 mm (0.035 in.)
Spark plug hex size		14 mm
Gearcase type		Sport Master
Gearcase capacity (RH, LH)		620 mL (21.0 fl oz)
Gear ratio		1.75:1
Recommended gasoline		Refer to Fuel and Oil
Recommended oil		Refer to Fuel and Oil
Engine oil capacity with oil filter replacement		6.6 Liter (7.0 US qt)
Required battery type		12-volt absorbed glass mat (AGM) battery
Battery type***	USA (SAE)	800 minimum marine cranking amps (MCA) with a minimum reserve capacity of 135 RC25 rating
	International (EN)	975 minimum cold cranking amps (CCA) with a minimum 65 amp hour (Ah)

GENERAL INFORMATION

*Engine at normal operation temperature.

**The idle charge compensation may automatically increase the engine speed up to 725 RPM to compensate for a low battery charge condition. The increased idle RPM will charge the battery at a higher rate. Activating troll control (optional accessory) will override the idle charge compensation feature.

***Battery manufacturers may rate and test their batteries to different standards. MCA, CCA, Ah, and reserve capacity (RC) are the ratings recognized by Mercury Marine. Manufacturers that use standards different than these, such as equivalent MCA, do not meet Mercury Marine battery requirements.

GENERAL INFORMATION

300R MODELS

Attribute		300R
Horsepower		300
Kilowatts		221
Full throttle RPM range		5800–6400
Idle RPM in neutral gear*		600
Idle charge compensation**		600–725
Troll control RPM limit		550–1000
Number of cylinders		8
Displacement		4.6 L 4,576 cc (279.2 cid)
Cylinder bore		92 mm (3.62 in.)
Stroke		86 mm (3.38 in.)
Spark plug		NGK LKAR7C-9
Spark plug gap		0.9 mm (0.035 in.)
Spark plug hex size		14 mm
137 mm (5.4 in.) ratio		1.75:1
Torque Master ratio		1.75:1
Sport Master ratio		1.75:1
Gearcase capacity	137 mm (5.4 in.) RH	720 mL (24.4 fl oz)
	137 mm (5.4 in.) LH	680 mL (23.0 fl oz)
	Torque Master	520 mL (17.5 fl oz)
	Sport Master RH, LH	620 mL (21.0 fl oz)
Recommended gasoline		Refer to Fuel and Oil
Recommended oil		Refer to Fuel and Oil
Engine oil capacity with oil filter replacement		6.6 L (7.0 US qt)
Required battery type		12-volt absorbed glass mat (AGM) battery
Battery rating***	USA (SAE)	800 minimum marine cranking amps (MCA) with a minimum reserve capacity of 135 RC25 rating
	International (EN)	975 minimum cold cranking amps (CCA) with a minimum 65 amp hour (Ah)

GENERAL INFORMATION

*Engine at normal operation temperature.

**The idle charge compensation may automatically increase the engine speed up to 725 RPM to compensate for a low battery charge condition. The increased idle RPM will charge the battery at a higher rate. Activating troll control (optional accessory) will override the idle charge compensation feature.

***Battery manufacturers may rate and test their batteries to different standards. MCA, CCA, Ah, and reserve capacity (RC) are the ratings recognized by Mercury Marine. Manufacturers that use standards different than these, such as equivalent MCA, do not meet Mercury Marine battery requirements.

Component Identification

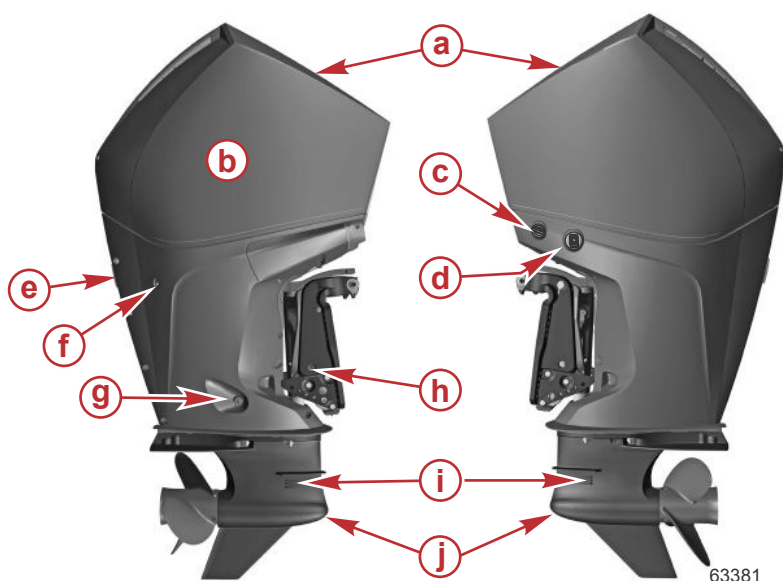

- a** - Service access door
- b** - Top cowl
- c** - Engine flush
- d** - Auxiliary tilt switch
- e** - Exhaust relief
- f** - Water pump indicator hole
- g** - Engine oil drain
- h** - Manual tilt release
- i** - Cooling water intake holes
- j** - Auxiliary cooling water intake holes

GENERAL INFORMATION

Gearcase Identification

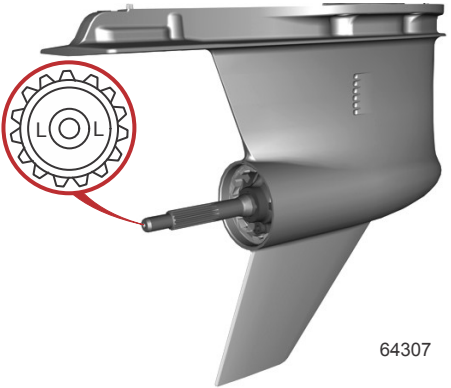
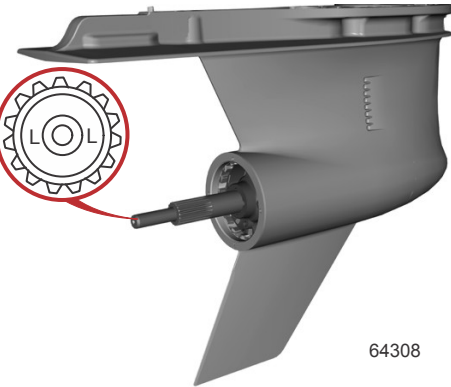
Diameter or Type	Identification Features	Illustration
122 mm (4.8 in.)	Water intake—six per side, four torpedo low water	 <p data-bbox="889 604 942 623">64307</p>
	Left-hand rotation gearcase—LL stamped on the end of propeller shaft	
137 mm (5.4 in.)	Water intake—eight per side, four torpedo low water	 <p data-bbox="878 1018 932 1037">64308</p>
	Left-hand rotation gearcase—LL stamped on the end of propeller shaft	

GENERAL INFORMATION

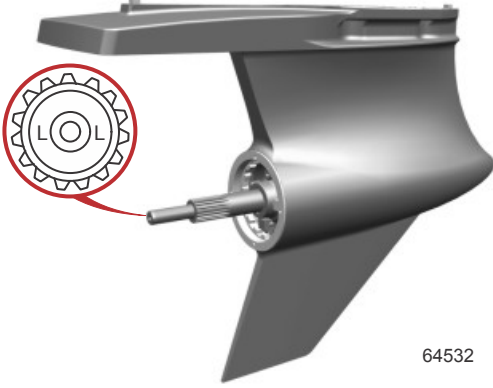
Diameter or Type	Identification Features	Illustration
Torque Master	Water intake—three or five per side, four torpedo low water	 <p style="text-align: right;">64269</p>
Sport Master	Water intake—three torpedo low water	 <p style="text-align: right;">64532</p>
	Left-hand rotation gearcase—LL stamped on the end of propeller shaft	

TRANSPORTING

Aquatic Invasive Species (AIS)



STOP AQUATIC HITCHHIKERS!™
Be A Good Steward. Clean. Drain. Dry.

For additional information, visit StopAquaticHitchhikers.org.

AIS and their spread can detrimentally impact the boating experience and the future of the boating lifestyle. Reducing the spread of AIS has led to significant national efforts to inspect boats moving between water bodies or across state and federal boundaries and could lead to delayed or denied access if AIS are suspected or found on board.

AIS include plant life such as Eurasian watermilfoil and water hyacinth, and animals such as spiny water flea, quagga, and zebra mussels. AIS may vary in size from microscopic, to easily visible to the naked eye, and can live in residual water or mud. These species damage ecosystems and negatively impact fishing by depleting natural food resources, altering the water environment, and changing the structure of the ecosystem.

The impact of AIS has already resulted in the limiting of boating access to many waterways throughout North America, the closure of public boat ramps, and the reduction of availability for fishing and boating across the United States. Many federal, state, and local agencies have enacted laws and regulations for inspections, permits, launch availability, and water access for vessels entering public waterways.

Boats and associated equipment are major contributors to the spread of AIS. Boats that have come into contact with AIS can become a means of transportation through attachment and entrapment.

You should be aware that water passes in and out of the space under the lower cowls on your engine during normal operation of the boat. When flushing and cleaning your boat to control the spread of AIS, pay attention to this space by directing flushing water into the spaces under the lower cowl. The engine cooling system can be flushed by operating the engine with the appropriate flushing attachment and introducing heated water to the engine.

For more information about the control of AIS in your area, please contact your area wildlife conservation office or local governmental natural resources office.

Trailing Boat/Outboard

Trailer your boat with the outboard tilted down in a vertical operating position.

TRANSPORTING

If additional ground clearance is required, the outboard should be tilted up using an accessory outboard support device. Refer to your local dealer for recommendations. Additional clearance may be required for railroad crossings, driveways, and trailer bouncing.

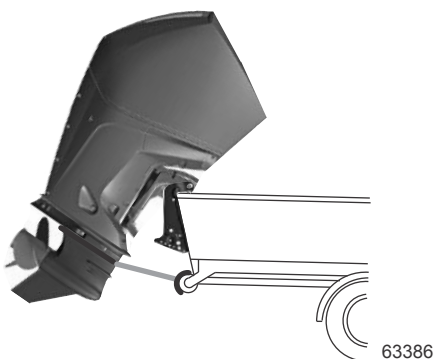

IMPORTANT: Do not rely on the power trim/tilt system or tilt support lever to maintain proper ground clearance for trailering. The outboard tilt support lever is not intended to support the outboard for trailering.

Shift the outboard to forward gear. This prevents the propeller from spinning.

FUEL AND OIL

Fuel Requirements

IMPORTANT: Use of improper gasoline can damage your engine. Engine damage resulting from the use of improper gasoline is considered misuse of the engine and will not be covered under the limited warranty.

FUEL RATINGS

Mercury outboard engines will operate satisfactorily with any major brand of unleaded gasoline that meets the following specifications:

USA and Canada - A posted pump octane rating of 87 (R+M)/2, minimum, for most models. Premium gasoline 91 (R+M)/2 octane is also acceptable for most models. **Do not** use leaded gasoline.

Outside USA and Canada - A posted pump octane rating of 91 RON, minimum, for most models. Premium gasoline (95 RON) is also acceptable for all models. **Do not** use leaded gasoline.

USING REFORMULATED (OXYGENATED) GASOLINE (USA ONLY)

Reformulated gasoline is required in certain areas of the USA and is acceptable for use in your Mercury Marine engine. The only oxygenate currently in use in the USA is alcohol (ethanol, methanol, or butanol).

GASOLINE CONTAINING ALCOHOL

Bu16 Butanol Fuel Blends

Fuel blends of up to 16.1% butanol (Bu16) that meet the published Mercury Marine fuel rating requirements are an acceptable substitute for unleaded gasoline. Contact your boat manufacturer for specific recommendations on your boat's fuel system components (fuel tanks, fuel lines, and fittings).

Methanol and Ethanol Fuel Blends

IMPORTANT: The fuel system components on your Mercury Marine engine will withstand up to 10% alcohol (methanol or ethanol) content in the gasoline. Your boat's fuel system may not be capable of withstanding the same percentage of alcohol. Contact your boat manufacturer for specific recommendations on your boat's fuel system components (fuel tanks, fuel lines, and fittings).

Be aware that gasoline containing methanol or ethanol may cause increased:

- Corrosion of metal parts
- Deterioration of rubber or plastic parts
- Fuel permeation through the rubber fuel lines
- Likelihood of phase separation (water and alcohol separating from the gasoline in the fuel tank)

FUEL AND OIL

WARNING

Fuel leakage is a fire or explosion hazard, which can cause serious injury or death. Periodically inspect all fuel system components for leaks, softening, hardening, swelling, or corrosion, particularly after storage. Any sign of leakage or deterioration requires replacement before further engine operation.

IMPORTANT: If you use gasoline that contains or might contain methanol or ethanol, you must increase the frequency of inspection for leaks and abnormalities.

IMPORTANT: When operating a Mercury Marine engine on gasoline containing methanol or ethanol, do not store the gasoline in the fuel tank for long periods. Cars normally consume these blended fuels before they can absorb enough moisture to cause trouble; boats often sit idle long enough for phase separation to take place. Internal corrosion may occur during storage if alcohol has washed protective oil films from internal components.

Fuel Additives

To minimize carbon deposit buildup in the engine, it is recommended to add Mercury or Quicksilver Quickstor fuel stabilizer additive to the engine's fuel at each tank fill throughout the boating season. Use additive as directed on container.

Low Permeation Fuel Hose Requirement

Required for outboards manufactured for sale, sold, or offered for sale in the United States.

- The Environmental Protection Agency (EPA) requires that any outboard manufactured after January 1, 2009, must use low permeation fuel hose for the primary fuel hose connecting the fuel tank to the outboard.
- Low permeation hose is USCG Type B1-15 or Type A1-15, defined as not exceeding 15 g/m²/24 h with CE 10 fuel at 23 °C as specified in SAE J 1527 - marine fuel hose.

Fuel Demand Valve (FDV) Requirement

Whenever a pressurized fuel tank is used, a fuel demand valve is required to be installed in the fuel hose between the fuel tank and the engine. The fuel demand valve prevents pressurized fuel from entering the engine and causing a fuel system overflow or possible fuel spillage.

FUEL AND OIL

The fuel demand valve has a manual release. The manual release can be used (pushed in) to open (bypass) the valve in case of a fuel blockage in the valve.



- a** - Fuel demand valve - installed in the fuel hose between the fuel tank and the engine
- b** - Manual release
- c** - Vent/water drain holes

Engine Oil Recommendations—Standard, Pro XS, and Race (R) Models

Mercury or Quicksilver NMMA™ FC-W® or NMMA FC-W catalyst compatible certified SAE® 10W-30 Mineral Marine 4-Stroke Engine Oil or SAE 10W-30 Synthetic Blend Marine 4-Stroke Engine Oil is recommended for general all-temperature use. As an optional choice, Mercury or Quicksilver SAE 25W-40 Mineral Marine 4-Stroke Engine Oil or SAE 25W-40 Synthetic Blend Marine 4-Stroke engine oil may be used. If the recommended Mercury or Quicksilver NMMA FC-W certified oils are not available, a major outboard manufacturer's brand of NMMA FC-W certified 4-Stroke outboard oil of similar viscosity may be used.

IMPORTANT: Nondetergent oils, multiviscosity oils (other than Mercury or Quicksilver NMMA FC-W certified oil or a major brand NMMA FC-W certified oil), full synthetic oils, low quality oils, and oils that contain solid additives are not recommended.

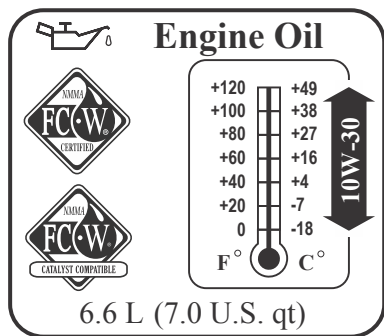

64064

FUEL AND OIL

Engine Oil Recommendations—SeaPro Models

Mercury or Quicksilver NMMA™ FC-W® or NMMA FC-W catalyst compatible certified SAE® 25W-40 Mineral Marine 4-Stroke Engine Oil or SAE 25W-40 Synthetic Blend Marine 4-Stroke Engine Oil is recommended for general all-temperature use. As an optional choice, Mercury or Quicksilver or SAE 10W-30 Mineral Marine 4-Stroke Engine Oil or SAE 10W-30 Synthetic Blend Marine 4-Stroke Engine Oil may be used when temperatures are 0 °C (32 °F) or less. If the recommended Mercury or Quicksilver NMMA FC-W certified oils are not available, a major outboard manufacturer's brand of NMMA FC-W certified 4-Stroke outboard oil of similar viscosity may be used.

IMPORTANT: Nondetergent oils, multiviscosity oils (other than Mercury or Quicksilver NMMA FC-W certified oil or a major brand NMMA FC-W certified oil), full synthetic oils, low quality oils, and oils that contain solid additives are not recommended.

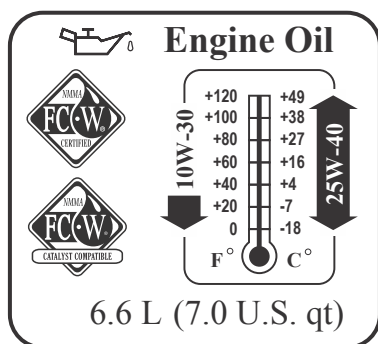

64063

Checking and Adding Engine Oil

IMPORTANT: Inspect oil for signs of contamination. Oil contaminated with water will have a milky color to it; oil contaminated with fuel will have a strong fuel smell. If contaminated oil is noticed, have the engine checked by your dealer.

IMPORTANT: Do not overfill. Tilt the outboard out/up past vertical for approximately one minute to allow trapped oil to drain back to the oil sump. The outboard must be in a vertical (not tilted) position when checking the engine oil. For accurate readings, check the oil only when the engine is cold or after the engine has not run for at least an hour.

1. Before starting a cold engine, tilt the outboard out/up past vertical to allow trapped oil to drain back to the oil sump. Allow the outboard to remain tilted for approximately one minute.
2. Tilt the outboard to a vertical operating position.

FUEL AND OIL

3. Push down on the port side of the service access door to unlock and open the door.

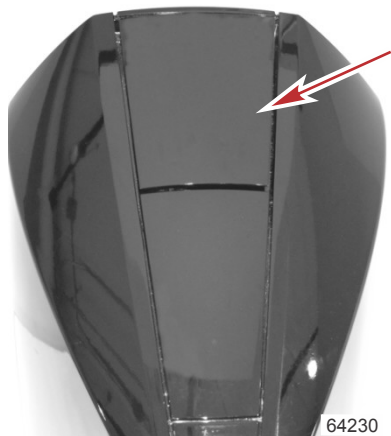

Push here to unlock

NOTE: On the underside of the service access door is a quick reference decal which lists the type of oil to use on various products.

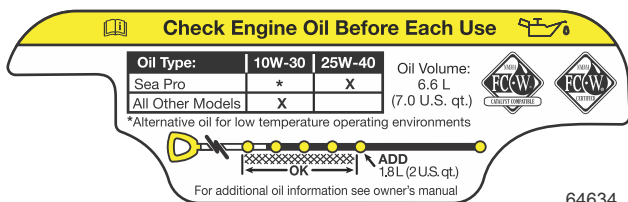

Quick reference decal

FUEL AND OIL

- Remove the dipstick and observe the area of the five beads.

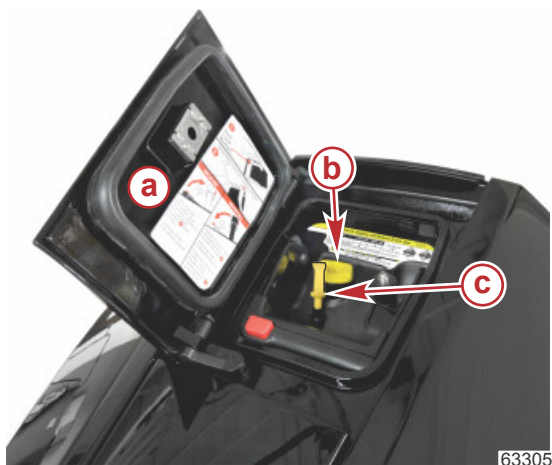

- a** - Service access door
- b** - Oil fill cap
- c** - Dipstick

- The bead or crosshatch which shows oil furthest from the end is the oil level.

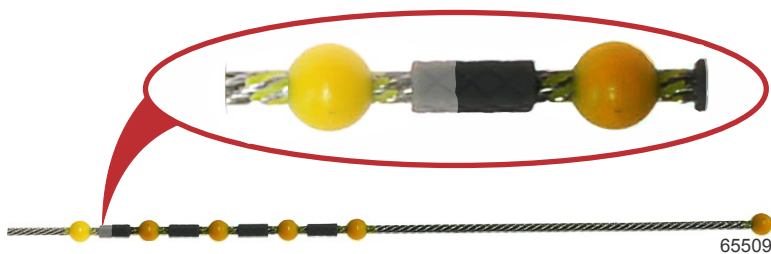

Oil level example

NOTE: New oil (level) may be difficult to identify which is why the crosshatch between the beads are part of the dipstick assembly. When checking the oil level, if oil is on any of the five oil range beads or four crosshatch, the oil level is within the safe operating range. When the oil level is only on the lowest oil range bead, the operator can add 1.8 Liter (2 US qt) of oil and the level will remain within the safe operating range. When the oil becomes dark from hours of product use, it will be easier to identify the oil level on the dipstick.

FUEL AND OIL

IMPORTANT: Repeated removal and insertion of the dipstick will subsequently deposit oil further up the dipstick tube which potentially may cause an error reading the oil level.

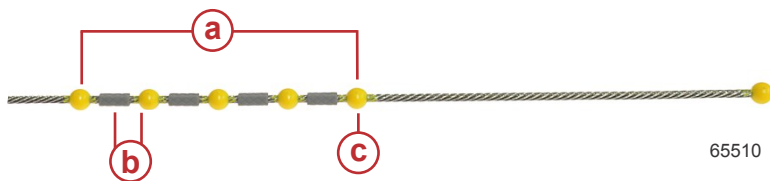

- a** - Safe operating range
 - b** - General area after an oil change
 - c** - Add 1.8 Liter (2 US qt) of oil
6. If none of the beads shows the oil level, remove the oil filler cap and add 1.8 Liter (2 US qt) of the specified outboard motor oil.
 7. Allow a few minutes for the oil to drain into the sump and insert the oil dipstick.
 8. Remove the dipstick and inspect if the oil level is within the safe operating range.
 9. Install the dipstick and oil filler cap hand-tight.
 10. Close the service access door and lock into place by pushing on the port side of the door.

FEATURES AND CONTROLS

Adaptive Speed Control

This outboard package utilizes adaptive speed control which automatically adjusts the engine load (throttle) to maintain engine speed (RPM). For example, when the boat operator steers into a hard turn, which results in increased load on the engine and a loss of RPM, the propulsion control module (PCM) will open the throttle to maintain RPM through the turn, without the need for the operator to increase the remote control throttle handle. Another example is when cruising or utilizing the boat for tow sports, engine speed will remain constant, regardless of load changes due to waves, trim position, turning or load changes from tow sports. Adaptive speed control is active from idle RPM up to max rated RPM, however, can only maintain engine speed when the throttle is less than wide open.

Remote Control Features

Your boat may be equipped with one of the Mercury Precision or Quicksilver remote controls shown. If not, consult your dealer for a description of the functions and operations of the remote control.



- a** - Trim/tilt switch – Refer to **Power Trim and Tilt**
- b** - Ignition key switch – OFF, ON, START
- c** - Throttle only button – Refer to **Operation – Starting the Engine**
- d** - Safety lanyard switch

Warning System

WARNING HORN SIGNALS

When the key switch is turned to the ON position, the horn will turn on for a moment as a test to indicate the horn is working.

There are two types of warning horns to alert the operator of an active problem within the engine's operating system.

FEATURES AND CONTROLS

1. **Continuous six second beep:** Indicates a critical engine condition. Depending on the condition, the Engine Guardian system may engage and protect the engine by limiting power. You should return to port immediately and contact your servicing dealer.
2. **Intermittent short beeps for six seconds:** Indicates a noncritical engine condition. This condition does not require immediate attention. You may continue using your boat, however, depending on the nature of the problem, the engine's power may be limited by the Engine Guardian system. Refer to **Engine Guardian System**. You should contact your servicing dealer at your earliest convenience.

It is important to note that in either of the above scenarios, the horn will only sound one time. If you key the engine off and restart it, the horn will sound again, one time, if the fault is still present. For visual display of the specific engine functions and additional engine data, refer to **SmartCraft Product** information, following.

A few of the noncritical conditions indicated by the intermittent short beeps for six seconds can be corrected by the operator. These operator correctable conditions are as follows:

- Water in the engine mounted fuel filter. Refer to **Maintenance - Low-Pressure Fuel Filter**.
- Cooling system (water pressure or engine temperature) problem. Stop the engine and check the water intake holes in the lower unit for obstruction.
- Low engine oil level. Refer to **Fuel and Oil - Checking and Adding Engine Oil**.

ENGINE GUARDIAN SYSTEM

The Engine Guardian system monitors the critical sensors on the engine for any early indications of problems. Engine Guardian is functional whenever your engine is operating, so you never have to be concerned about whether or not you are protected. The system will respond to a problem by sounding the warning horn for six seconds and/or reducing engine power in order to provide engine protection.

If Engine Guardian has been activated, reduce the engine speed. The problem will need to be identified and corrected. The system must be reset before the engine will operate at higher speeds. Moving the throttle lever back to the idle position will reset the Engine Guardian system. If the Engine Guardian system has determined the reset has not corrected the problem, Engine Guardian will remain activated, limiting the throttle. The problem must be identified and corrected before Engine Guardian will allow the engine to reach a normal operating RPM.

FEATURES AND CONTROLS

OVERSPEED REV LIMIT

The overspeed rev limit is set at an RPM greater than the operating range. In the event that the engine is operated at an RPM greater than or equal to the overspeed limit, the PCM does not allow the engine to maintain the power requested by the operator. Refer to **General Information - Specification** to determine this engine's RPM limit.

Upon reaching the beginning of the overspeed rev limit, Engine Guardian will cut fuel to one bank of cylinders. If the operator does not reduce engine speed, Engine Guardian will cut the fuel to all cylinders until the engine speed has dropped below the rev limit. There is no audible warning while Engine Guardian overspeed limit is active.

SMARTCRAFT PRODUCT

A Mercury SmartCraft System instrument package can be purchased for this outboard. A few of the functions the instrument package will display are engine RPM, coolant temperature, oil pressure, water pressure, battery voltage, fuel consumption, and engine operating hours.

The SmartCraft instrument package will also aid in Engine Guardian diagnostics. The SmartCraft instrument package will display critical engine alarm data and potential problems.

EXHAUST GAS OVER TEMPERATURE

When the Engine Guardian system detects the exhaust gas temperature is high (fault code 2124-20), the warning horn will beep and the engine RPM will be limited. SmartCraft gauges which have the ability display text, will alert the operator with a short text, long text, and the action which the operator should follow. This Guardian warning and engine power reduction can possibly be corrected by inspecting the gear housing water inlet for blockage and the exhaust water strainer for blockage. Refer to **Maintenance - Exhaust Water Strainer Inspection**.

SmartCraft Displayed Text	
Short text	Critical - Overtemp
Long text	Engine exhaust manifold is overheating
Action	Stop engine and check for plugged exhaust water strainer. If condition persists return to port immediately. Service engine before next use.

1. Stop the engine.
2. Check the gear housing water inlet for blockage.
3. Check the exhaust water strainer for blockage. Refer to **Maintenance - Exhaust Water Strainer Inspection**.
4. If there is no blockage and the condition persists, return to port immediately.

FEATURES AND CONTROLS

LOSS OF SHIFT COMMAND

When the Engine Guardian system detects a loss of shift control (fault code 339-23), the warning horn will beep and the engine RPM will be limited. SmartCraft gauges which have the ability to display text will alert the operator with a short text, long text, and the action which the operator should follow.

SmartCraft Displayed Text	
Short text	Reverse Gear Unavailable
Long text	Reverse gear is not available. Moving control lever into reverse will result in a forward gear shift. Engine power is limited.
Action	Return to port immediately - Service engine before next use.

IMPORTANT: Engine Guardian loss of shift command will only allow the engine to be shifted into forward or neutral; access to reverse gear is not possible.

Operation of the outboard will be extremely limited when the Engine Guardian system detects a loss of shift control fault. The outboard will only shift from neutral to forward after the remote control handle is advanced to approximately the mid-throttle position. Engine RPM will not increase until after forward gear engagement. The throttle will be limited to approximately 1000 RPM to allow emergency boat operation. If the remote control shift handle is moved from neutral into reverse, the lower unit will shift into forward gear.

Power Trim and Tilt

The outboard has a trim/tilt control called power trim. This enables the operator to easily adjust the position of the outboard by pressing the trim switch. Moving the outboard in closer to the boat transom is called trimming in or down. Moving the outboard further away from the boat transom is called trimming out or up. The term trim generally refers to the adjustment of the outboard within the first 20° range of travel. This is the range used while operating the boat on plane. The term tilt is generally used when referring to adjusting the outboard further up out of the water. The outboard can be tilted up past the trim range for shallow water operation or loading the boat onto a trailer. With the engine turned off and ignition switch turned on, the outboard can be tilted out of the water.

- Below 2000 RPM the engine can be trimmed or tilted to any range. Caution is advised when operating the engine past the tilt range. Ensure the water pickups are submerged.
- While in the trim range and the engine is above 2000 RPM, you can only trim to the maximum trim range.
- If the engine is below 2000 RPM and is in the trailer range, advancing the throttle will allow the engine to achieve a maximum RPM of 4250. Engine operation in this capacity (above the normal 2000 limit) should only be used for loading or unloading the boat onto or off the trailer. It should not be used during normal boat operation.

FEATURES AND CONTROLS

NOTE: Exceeding 4250 RPMs the engine PCM will begin Engine Guardian protection.

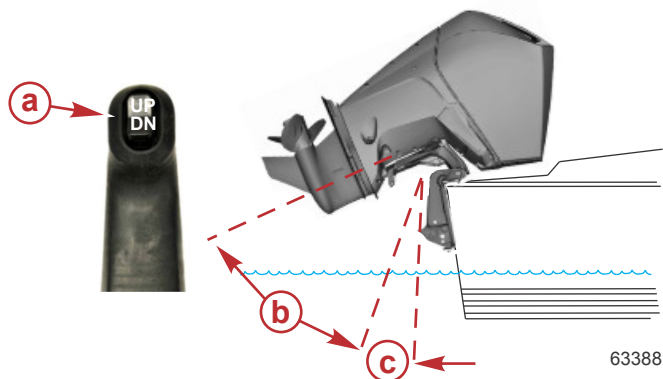

- a - Trim switch
- b - Tilt range
- c - Trim range

POWER TRIM OPERATION

With most boats, operating around the middle of the trim range will give satisfactory results. However, to take full advantage of the trimming capability there may be times when you choose to trim your outboard all the way in or out. Along with an improvement in some performance aspects comes a greater responsibility for the operator, and this is being aware of some potential control hazards.

The most significant control hazard is a pull or torque that can be felt on the steering wheel or tiller handle. This steering torque results from the outboard being trimmed so the propeller shaft is not parallel to the water surface.

▲ WARNING

Trimming the outboard beyond a neutral steering condition may result in a pull on the steering wheel or tiller handle and loss of boat control. Maintain control of the boat if trimming beyond a neutral steering condition.

Consider the following lists carefully.

1. Trimming in or down can:
 - Lower the bow
 - Result in quicker planing off, especially with a heavy load or a stern heavy boat
 - Generally improve the ride in choppy water

FEATURES AND CONTROLS

- Increase steering torque or pull to the right (with the normal right-hand rotation propeller)
 - In excess, can lower the bow of some boats to a point where they begin to plow with their bow in the water while on plane. This can result in an unexpected turn in either direction (called bow steering or oversteering) if any turn is attempted, or if a significant wave is encountered.
2. Trimming out or up can:
- Lift the bow higher out of the water
 - Generally increase top speed
 - Increase clearance over submerged objects or a shallow bottom
 - Increase steering torque or pull to the left at a normal installation height (with the normal right-hand rotation propeller)
 - In excess, can cause boat porpoising (bouncing) or propeller ventilation
 - Cause engine overheating if any cooling water intake holes are above the waterline

TILTING OPERATION

To tilt outboard, shut off the engine and press the trim/tilt switch or auxiliary tilt switch to the up position. The outboard will tilt up until the switch is released or it reaches its maximum tilt position.

1. Engage the tilt support lever by rotating the knob to bring the support lever upward.
2. Lower the outboard to rest on the tilt support lever.
3. Disengage the tilt support lever by raising the outboard off the support lever and rotating the lever down. Lower the outboard.

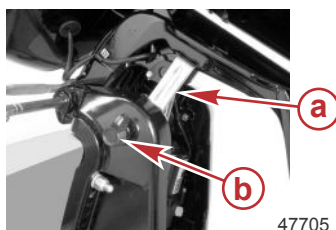

- a - Tilt support lever
- b - Knob

MANUAL TILTING

If the outboard cannot be tilted using the power trim/tilt switch, the outboard can be manually tilted.

NOTE: *The manual tilt release valve must be tightened before operating the outboard to prevent the outboard from tilting up during reverse operation.*

FEATURES AND CONTROLS

Turn out the manual tilt release valve three turns counterclockwise. This allows manual tilting of the outboard. Tilt the outboard to the desired position and tighten the manual tilt release valve.



AUXILIARY TILT SWITCH

This switch can be used to tilt the outboard up or down using the power trim system.



a - Auxiliary tilt switch

OPERATING IN SHALLOW WATER

When operating your boat in shallow water, you can tilt the outboard beyond the maximum trim range to prevent hitting bottom.

1. Reduce the engine speed below 2000 RPM.
 2. Tilt the outboard up. Make sure all the cooling water intake holes stay submerged at all times.
- Below 2000 RPM the engine can be trimmed or tilted to any range. Caution is advised when operating the engine past the tilt range. Ensure the water pickups are submerged.
 - If the engine is below 2000 RPM and is in the trailer range, advancing the throttle will allow the engine to achieve a maximum RPM of 4250. Engine operation in this capacity (above the normal 2000 limit) should only be used for loading or unloading the boat onto or off the trailer. It should not be used during normal boat operation.

NOTE: Exceeding 4250 RPMs the engine PCM will begin Engine Guardian protection.

OPERATION

Important Daily Inspection Before Each Use

Any outboard mounted on the boat must have the mounting hardware inspected and checked to ensure that the hardware has not become loose. A decal on the transom bracket reminds the owner to check the fasteners securing the outboard to the transom before each use.

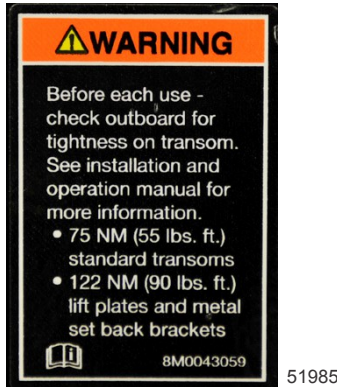

Decal on the transom bracket

Prestarting Check List

- Operator knows safe navigation, boating, and operating procedures.
- An approved personal flotation device of suitable size for each person aboard and readily accessible (it is the law).
- A ring type life buoy or buoyant cushion designed to be thrown to a person in the water.
- Know your boat's maximum load capacity. Look at the boat capacity plate.
- Fuel supply OK.
- Arrange passengers and load in the boat so the weight is distributed evenly and everyone is seated in a proper seat.
- Tell someone where you are going and when you expect to return.
- It is illegal to operate a boat while under the influence of alcohol or drugs.
- Know the waters and area you will be boating; tides, currents, sand bars, rocks, and other hazards.
- Make inspection checks listed in **Maintenance - Inspection and Maintenance Schedule**.

Operating in Freezing Temperatures

If there is a chance of ice forming on the water, the outboard should be removed and drained completely of water. If ice should form at any level inside the outboard driveshaft housing between the water pump and the powerhead, it will block cooling water flow to the engine which may cause possible damage.

OPERATION

If the boat cannot be removed from the water during freezing temperatures, the outboard should be tilted up so the trailing edge of the antivibration plate is protruding slightly above the water surface—refer to the following graphic illustration. At this tilt angle, the engine's water pump and cooling water passages are best protected from freezing up with ice.

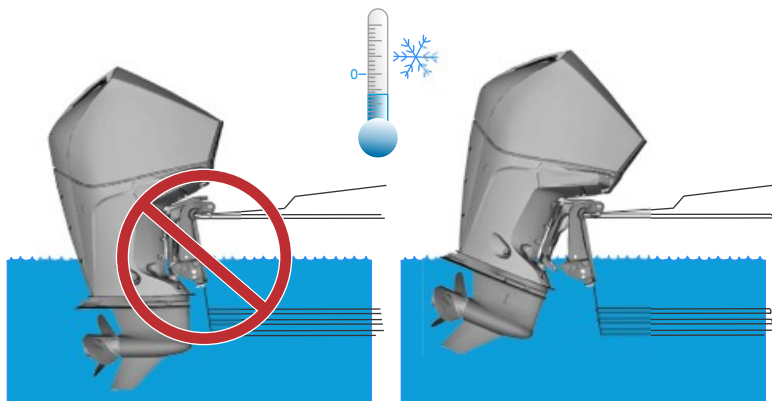

64809

Operating in Saltwater or Polluted Water

We recommend that you flush the internal water passages of your outboard with fresh water after each use in salt or polluted water. This will prevent a buildup of deposits from clogging the water passages. Refer to **Maintenance - Flushing the Cooling System**.

If you keep your boat moored in the water, always tilt the outboard so the gearcase is completely out of water (except in freezing temperatures) when not in use.

Wash the outboard exterior and flush out the exhaust outlet of the propeller and gearcase with fresh water after each use. Each month, spray Mercury or Quicksilver Corrosion Guard on external metal surfaces. Do not spray on corrosion control anodes as this will reduce the effectiveness of the anodes.

Tube Ref No.	Description	Where Used	Part No.
 120	Corrosion Guard	External metal surfaces	92-802878 55

OPERATION

IMPORTANT: Do not rinse the cowls with water when the outboard is in a tilted position, as this could allow water to enter the air intakes on the rear of the upper cowl. Always lower the outboard to a vertical position prior to rinsing the cowls.

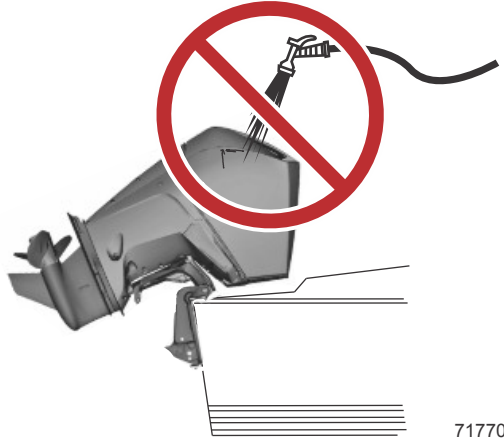

Do not rinse cowl while outboard is tilted

Operating at High Elevations

Your engine automatically compensates for high elevation changes. A different pitch propeller may help reduce some normal performance loss resulting from reduced oxygen in the air. Consult your dealer.

Effects of Elevation and Weather on Performance

The following conditions lower engine performance and cannot be compensated by the engine fuel or electronic management systems:

- Above sea level elevations
- High temperature
- Low barometric pressure
- High humidity

These conditions above reduce air density to the engine, which in turn lowers the following:

- Boost pressure on supercharged engines
- Horsepower and torque throughout the RPM range
- Peak RPM
- Cranking compression

EXAMPLE: An engine running at an elevation of 8,000 feet will have over a 30% power loss while a loss of engine power on a hot and humid day could be as much as 14%. These losses apply to normally aspirated and supercharged engines.

OPERATION

Compensating for power robbing conditions:

- Switch to lower pitch propeller.
- Change gear ratio (if available).

Some boat performance can be improved by dropping to a lower pitch propeller, but engine performance will still remain lower. In some cases, a gear ratio reduction may be more beneficial. To optimize engine performance, prop the engine to allow it to operate at or near the top end of the recommended maximum RPM range at wide-open throttle with a normal boat load.

Other advantages to propeller or gear ratio changes:

- Reduces the possibility of detonation
- Enhances overall reliability and durability of the engine

Setting Trim Angle while Running Engine at Idle Speed

The exhaust relief hole on the outboard can become submerged on some boats if the engine is trimmed full in while running at idle speed. This may result in exhaust restriction, rough idle, excessive smoke, and fouled spark plugs. If this condition exists, trim outboard up until exhaust relief hole is out of the water.

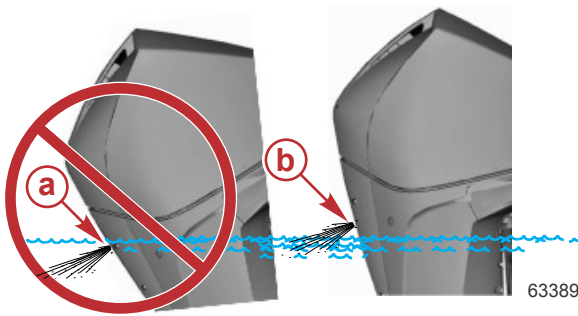

- a** - Relief hole submerged (wrong)
- b** - Relief hole above waterline (correct)

Engine Break-in Procedure

IMPORTANT: Failure to follow the engine break-in procedures can result in poor performance throughout the life of the engine and can cause engine damage. Always follow break-in procedures.

1. For the first two hours of operation, run the engine at varied throttle settings up to 4500 RPM or at three-quarter throttle, and at full throttle for approximately one minute every ten minutes.
2. For the next eight hours of operation, avoid continuous operation at full throttle for more than five minutes at a time.

OPERATION

Fuel Supply Module Priming Procedure

The fuel supply module (FSM) is not vented to the ambient air. The air trapped in the FSM, fuel lines, and fuel rail, will be slightly compressed during the initial ignition key on with a dry or drained fuel system. Additional key on events under these conditions, will not compress the air further to finish the priming of the FSM. Excessive number of key on events may eventually damage the fuel pumps. The volume of air trapped in the FSM must be purged to prime the fuel system. This can be achieved by connecting a tool to the fuel rail Schrader valve fitting to quickly purge the system into an approved container, or by cranking the engine.

PRIMING THE FSM WITH A PURGE TOOL

The use of a purge tool for priming the FSM is the preferred method, but is not always practical. The objective is to purge the air entrained in the fuel system through a purge tool connected to the fuel rail Schrader valve test port. During the key on, opening the dump valve will allow the air to be purged from the FSM and fuel rail. This method should be used on vessels when the fuel system leading to the outboard is restrictive; antisiphon valve or holds a relatively large volume of fuel because of a long fuel supply line or a vessel mounted water-separating fuel filter is installed. If a primer bulb is installed, it can be used during the priming event to shorten the amount of time required to start the engine.

1. Verify the engine is in a level vertical position.
2. Verify the vessel fuel supply line is connected to the outboard fuel system inlet fitting.
3. Connect a fuel pressure gauge to the fuel rail Schrader valve.
4. Secure the fuel pressure gauge purge hose into an appropriate fuel container to collect excess fuel.
5. Open the fuel pressure gauge purge valve and turn the ignition key ON. The fuel pumps will run for approximately five seconds.
6. Turn the ignition key OFF and then back ON. The fuel pumps will run for approximately five seconds. Continue this ignition key cycle until the purged fuel is relatively clear of air bubbles.

NOTE: *If the outboard fuel system does not prime within 15 key ON events, check for leaks in the fuel supply line to the outboard. Repair as needed. If no leak is found, the fuel supply system to the outboard may be too restrictive. Correct the condition and try again.*

7. Remove the fuel pressure gauge.
8. Turn the ignition key ON. When the fuel pumps stop running, start the engine. The engine may not start on the first attempt. The engine will run rough at idle for up to two minutes while the residual air is purged from the fuel system.

OPERATION

PRIMING THE FSM (RAN OUT OF FUEL CONDITION)

The use of a purge tool for priming the FSM is the preferred method, but is not always practical. When the vessel fuel system is void of fuel volume, it can be primed without the use of a purge tool. The objective is to purge the air entrained in the fuel system through the fuel injectors during engine cranking to allow fuel to enter the fuel module. This method can be used on vessels where the fuel inlet system to the outboard is less restrictive and holds a relatively small volume of fuel; a short fuel supply line, no water-separating fuel filter, or water-separating fuel filter is already primed. If a primer bulb is installed, it can be used during the priming event to shorten the amount of time required to start the engine.

NOTE: *In most cases, the priming procedure can be accomplished by purging the air from one fuel rail.*

1. Verify the engine is in a level vertical position.
2. Verify the vessel fuel supply line is connected to the outboard fuel system inlet fitting.
3. Turn the ignition key ON. The fuel pumps will run for approximately five seconds.
4. Turn the ignition key to the START position and release the key. The ECM controls the activation of the starter. The starter may continue cranking for up to eight seconds.

NOTE: *When priming a drained fuel system, residual fuel may cause the engine to flare and stall which shortens the engine cranking event.*

5. Continue with the ignition key ON and START sequence until the engine continues to run.

IMPORTANT: Allow the starter motor to cool for 20 to 30 seconds between full eight second crank events. Limit the number of events to a maximum of 10 full eight second cranking events.

6. Once the engine starts, it may run rough at idle for up to two minutes while the residual air is purged from the fuel system.
7. If the fuel system will not prime within 10 full eight second cranking events, use the previous procedure **Priming the FSM with a Purge Tool** to prime the fuel system.

Starting the Engine

Before starting, read the **Prestarting Check List**, and **Engine Break-in Procedure** in this section.

NOTICE

Without sufficient cooling water, the engine, the water pump, and other components will overheat and suffer damage. Provide a sufficient supply of water to the water inlets during operation.

OPERATION

1. Push down on the port side of the service access door to unlock and open the door.

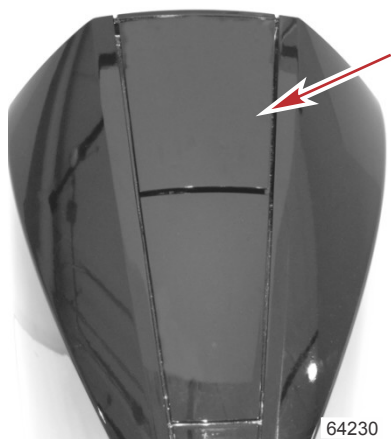

Push here to unlock

2. Check the engine oil level. Refer to **Fuel and Oil - Checking and Adding Engine Oil**.

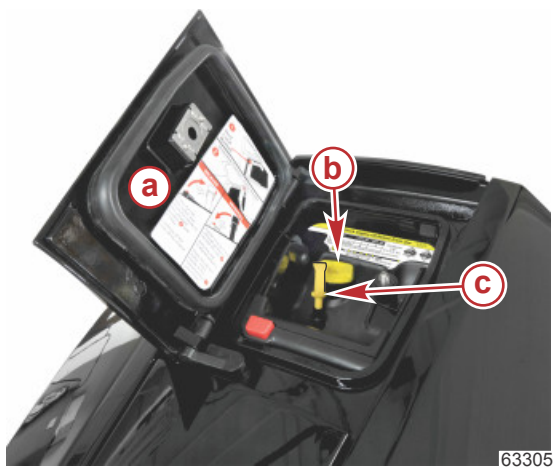

- a** - Service access door
- b** - Oil fill cap
- c** - Dipstick

OPERATION

3. Ensure the cooling water intake is submerged.

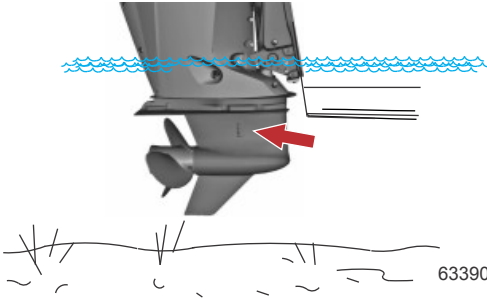

4. Open the fuel tank vent screw (in filler cap) on manual venting type fuel tanks.

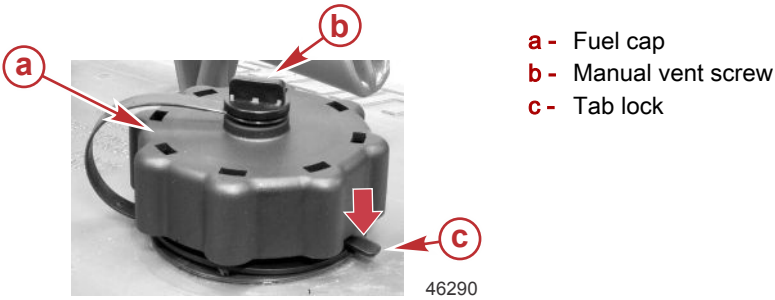

5. Set the lanyard stop switch to the RUN position. Refer to **General Information - Lanyard Stop Switch**.

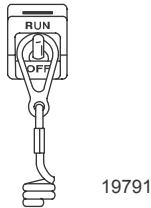

OPERATION

- Shift the outboard to neutral (N) position.



- Ignition key starting - Turn the ignition key to the START position and release the key. The electronic starting system will automatically crank the engine for starting. If the engine fails to start, the engine will stop cranking. Turn the key to the START position again until the engine starts.

NOTE: For initial start of a new engine or for an engine that ran out of fuel or was drained of fuel, the fuel system should be filled as follows:

Turn the ignition key switch to the ON position for approximately five seconds. Turn the key to the START position and release it, the engine will crank for a maximum of eight seconds. The engine may start, run rough, and stall while filling the system. Repeat this starting procedure until the engine remains running. Allow the starter motor to cool for 20–30 seconds between start attempts.

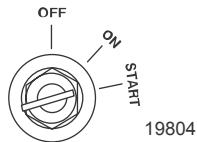

- After the engine starts, check for a steady stream of water flowing out of the water pump indicator hole.

IMPORTANT: If no water is coming out of the water pump indicator hole, stop the engine and check the cooling water intake for obstruction. No obstruction may indicate a water pump failure or blockage in the cooling system. These conditions will cause the engine to overheat. Have the outboard checked by your dealer. Operating the engine while overheated will cause engine damage.

WARMING UP ENGINE

Before beginning operation, allow the engine to warm up at idling speed for three minutes.

OPERATION

Gear Shifting

IMPORTANT: Observe the following:

- **Never shift the outboard into or out of gear unless the engine speed is at idle.** Shifting at higher than engine idle speed could cause damage to the gearcase.
- **Do not shift the outboard into reverse when the forward motion of the boat is greater than a no wake speed.** Shifting into reverse at higher boat speeds could cause the engine to stall, and in some situations, this could cause water to be drawn into the cylinders, resulting in severe engine damage.
- **Do not shift the outboard into reverse when the engine is not running.** Damage to the shift linkage could occur.
- The outboard has three gear shift positions: forward (F), neutral (N), and reverse (R).
- When shifting, always stop at the neutral position and allow the engine idle speed to stabilize before shifting into another gear.
- Always shift the outboard into gear with a quick motion.
- After shifting the outboard into gear, advance the lever further to increase speed.



Stopping the Engine

Reduce the engine speed and shift the outboard to neutral position. Turn the ignition key to OFF position.

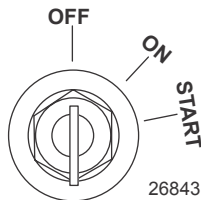

OPERATION

Proper Outboard Tilt Positioning During Periods of Non-Use

With the engine turned off, tilt the outboard up to a point where the trailing edge of the anti-ventilation plate is angled higher than the leading edge.

With the engine off, the outboard tilt angle will:

- Help to eliminate or reduce engine smoke on start-up. Tilting the outboard up, allows oil in the cylinders to run down cylinders and return to the oil sump. With the outboard level or tilted in, oil from the cylinder walls can run down to the bottom of the cylinder and form a puddle behind the piston/rings. The oil can then weep into the combustion chamber. When the engine is started, the oil in the combustion chamber will burn, creating smoke on start-up condition. As the engine runs, the smoke will gradually clear as the oil is consumed.
- Provides additional impact clearance for the gearcase/propeller, when the boat is at rest in shallow water. Tides and wave action can vary the waters depth and reduce the impact clearance between the gearcase/propeller and the bottom.

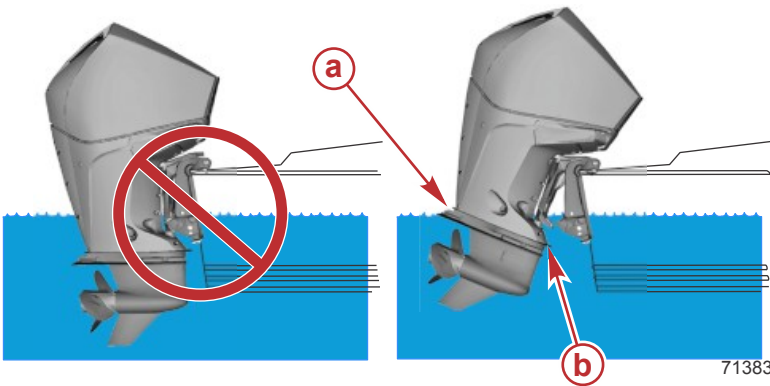

a - Trailing edge of anti-ventilation plate

b - Leading edge of anti-ventilation plate

MAINTENANCE

Cleaning Care Recommendations

OUTBOARD CARE

To keep your outboard in the best operating condition, it is important that your outboard receive the periodic inspections and maintenance listed in the **Inspection and Maintenance Schedule**. We urge you to keep it maintained properly to ensure the safety of you and your passengers, and retain its dependability.

Record maintenance performed in the **Maintenance Log** at the back of this book. Save all maintenance work orders and receipts.

Selecting Replacement Parts For Your Outboard

We recommend using original Mercury Precision or Quicksilver replacement parts and Genuine Lubricants.

DO NOT USE CAUSTIC CLEANING CHEMICALS

IMPORTANT: Do not use caustic cleaning chemicals on the outboard power package. Some cleaning products contain strong caustic agents such as hull cleaners with hydrochloric acid. These cleaners can degrade some of the components they come in contact with including critical steering fasteners.

Damage to steering fasteners may not be obvious during visual inspection and this damage may lead to catastrophic failure. Some caustic cleaning chemicals may cause or accelerate corrosion. Exercise caution when using cleaning chemicals around the engine and follow the recommendations on the packaging of the cleaning product.

CLEANING GAUGES

IMPORTANT: Never use high-pressure water to clean gauges.

Routine cleaning of the gauges is recommended to prevent a buildup of salt and other environmental debris. Crystalized salt can scratch the gauge display lens when using a dry or damp cloth. Ensure that the cloth has a sufficient amount of fresh water to dissolve and remove salt or mineral deposits. Do not apply aggressive pressure on the display lens while cleaning.

When water marks cannot be removed with a damp cloth, mix a 50/50 solution of warm water and isopropyl alcohol to clean the display lens. **Do not use** acetone, mineral spirits, turpentine type solvents, or ammonia based cleaning products. The use of strong solvents or detergents may damage the coating, the plastics, or the rubber keys on the gauges. If the gauge has a sun cover available, it is recommended that the cover be installed when the unit is not in use to prevent UV damage to the plastic bezels and rubber keys.

CLEANING REMOTE CONTROLS

IMPORTANT: Never use high-pressure water to clean remote controls.

MAINTENANCE

Routine cleaning of the remote control external surfaces is recommended to prevent a buildup of salt and other environmental debris. Use a cloth towel which has a sufficient amount of fresh water to dissolve and remove salt or mineral deposits.

When water marks cannot be removed with a damp cloth, mix a 50/50 solution of warm water and isopropyl alcohol to clean the remote control. **Do not use** acetone, mineral spirits, turpentine type solvents, or ammonia based cleaning products. The use of strong solvents or detergents may damage the coating, the plastics, or the rubber components on the remote control.

CLEANING CARE FOR TOP AND BOTTOM COWLS

IMPORTANT: Dry wiping (wiping the plastic surface when it is dry) will result in minor surface scratches. Always wet the surface before cleaning. Do not use detergents containing hydrochloric acid. Follow the cleaning and waxing procedure.

Cleaning and Waxing Procedure

1. Before washing, rinse the cowls with clean water to remove dirt and dust that may scratch the surface.
2. Wash the cowls with clean water and a mild nonabrasive soap. Use a soft clean cloth when washing.
3. Dry thoroughly with a soft clean cloth.
4. Wax the surface using a nonabrasive automotive polish (polish designed for clear coat finishes). Remove the applied wax by hand using a clean soft cloth.
5. To remove minor scratches, use Mercury Marine Cowl Finishing Compound (92-859026K 1).

MAINTENANCE

IMPORTANT: Do not rinse the cowls with water when the outboard is in a tilted position, as this could allow water to enter the air intakes on the rear of the upper cowl. Always lower the outboard to a vertical position prior to rinsing the cowls.

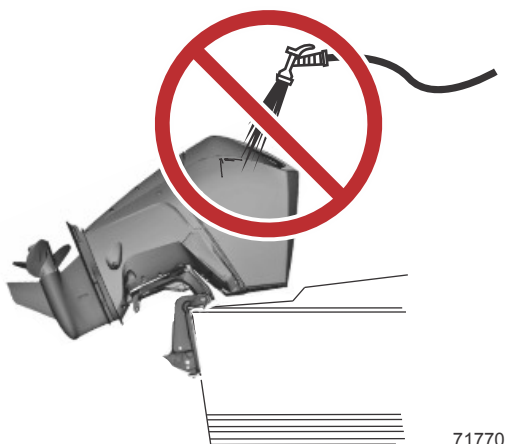

Do not rinse cowl while outboard is tilted

CLEANING CARE FOR THE POWERHEAD (SALTWATER USE)

If the outboard is operated in saltwater, remove the top cowl and flywheel cover. Inspect the powerhead and powerhead components for salt buildup. Wash off any salt buildup from the powerhead and powerhead components with fresh water. Keep water spray out of the air filter/intake and alternator. After washing, allow the powerhead and components to dry. Apply Quicksilver or Mercury Corrosion Guard spray on the external metal surfaces of the powerhead and powerhead components. Do not allow the Corrosion Guard spray to come in contact with the alternator drive belt or belt pulleys.

IMPORTANT: Do not allow lubricant or Corrosion Guard spray to come in contact with the alternator drive belt or the belt pulleys. The alternator drive belt could slip and be damaged if it becomes coated with any lubricant or Corrosion Guard spray.

Tube Ref No.	Description	Where Used	Part No.
 120	Corrosion Guard	External metal surfaces of the powerhead and powerhead components.	92-802878 55

MAINTENANCE

EPA Emissions Regulations

All new outboards manufactured by Mercury Marine are certified to the United States Environmental Protection Agency, as conforming to the requirements of the regulations for the control of air pollution from new outboard motors. This certification is contingent on certain adjustments set to factory standards. For this reason, the factory procedure for servicing the product must be strictly followed and, wherever practicable, returned to the original intent of the design.

Maintenance, replacement, or repair of the emission control devices and systems may be performed by any marine spark ignition (SI) engine repair establishment or individual.

EMISSION CERTIFICATION LABEL

An emission certification label, showing emission levels and engine specifications directly related to emissions, is placed on the engine at the time of manufacture.

The diagram shows a rectangular label with the Mercury logo on the left and the title "EMISSION CONTROL INFORMATION" on the right. The label contains the following text and fields:

- THIS ENGINE CONFORMS TO CALIFORNIA AND U.S. EPA EMISSION REGULATIONS FOR SPARK IGNITION MARINE ENGINES
- REFER TO OWNERS MANUAL FOR REQUIRED MAINTENANCE, SPECIFICATIONS, AND ADJUSTMENTS
- IDLE SPEED (in gear): RPM
- FAMILY:
- hp
- L
- HC+NOx:FEL: g/kWh
- kw
- CO FEL: g/kWh
- SPARK PLUG:
- GAP:
- LOW PERM/HIGH PERM:

Callouts a-j point to the following fields:

- a - Idle speed
- b - Engine horsepower
- c - Piston displacement
- d - Engine power - kilowatts
- e - Date of manufacture
- f - US EPA engine family name
- g - Regulated emission limit for the engine family
- h - Regulated emission limit for the engine family
- i - Recommended spark plug and gap
- j - Percent of fuel line permeation

43210

- a - Idle speed
- b - Engine horsepower
- c - Piston displacement
- d - Engine power - kilowatts
- e - Date of manufacture
- f - US EPA engine family name
- g - Regulated emission limit for the engine family
- h - Regulated emission limit for the engine family
- i - Recommended spark plug and gap
- j - Percent of fuel line permeation

OWNER RESPONSIBILITY

The owner/operator is required to have routine engine maintenance performed to maintain emission levels within prescribed certification standards.

The owner/operator is not to modify the engine in any manner that would alter the horsepower or allow emission levels to exceed their predetermined factory specifications.

MAINTENANCE

Inspection and Maintenance Schedule

BEFORE EACH USE

- Check engine oil level. Refer to **Checking Engine Oil Level**.
- Check that the lanyard stop switch stops the engine.
- Inspect the outboard for tightness to the boat transom. If any looseness of the outboard or mounting fasteners exist, tighten the outboard mounting fasteners to the specified torque. When looking for signs of looseness, look for loss of outboard transom bracket material or paint caused by movement between the outboard mounting fasteners and the outboard transom brackets. Also look for signs of movement between the outboard transom brackets and the boat transom (lift plate/setback bracket).

Description	Nm	lb-in.	lb-ft
Outboard mounting locknuts and bolts - standard boat transom	75	–	55.3
Outboard mounting locknuts and bolts - metal lift plates and setback brackets	122	–	90

- Visually inspect the fuel system for deterioration or leaks.
- Check the steering system for binding or loose components.
- Check the propeller blades for damage.
- Inspect the hydraulic steering fittings and hoses for leaks or damage, if equipped.
- Inspect the hydraulic steering fluid level, if equipped.

AFTER EACH USE

- Flush out the outboard cooling system if operating in salt, polluted, or muddy water. Refer to **Flushing the Cooling System**.
- Wash off all salt deposits and flush out the exhaust outlet of the propeller and gearcase with fresh water if operating in saltwater.
- If operating in saltwater, inspect the powerhead and powerhead components for salt buildup. Refer to **Cleaning Care for the Powerhead (Saltwater Use)**.

EVERY 100 HOURS OF USE OR ONCE YEARLY, WHICHEVER OCCURS FIRST

- Inspect the exhaust water strainer. Refer to **Exhaust Water Strainer Inspection**.
- Change engine oil and replace the oil filter. The oil should be changed more often when the engine is operated under adverse conditions, such as extended trolling. Refer to **Changing Engine Oil and Filter**.

MAINTENANCE

- Check the engine mounted water-separating low-pressure fuel filter for water or contaminants. Replace the filter if required. Refer to **Fuel System**.
- Check the boat mounted water-separating fuel filter for the presence of water or contaminants. Drain the water or replace the filter if required.
- Remove the propeller and lubricate the propeller shaft. Refer to **Propeller Replacement**.
- Inspect the thermostat visually for corrosion or a broken spring. Ensure the thermostat closes completely at room temperature—dealer service.
- Check the outboard mounting fasteners that fasten the outboard to the boat transom. Tighten the fasteners to the specified torque—dealer service.

Description	Nm	lb-in.	lb-ft
Outboard mounting locknuts and bolts - standard boat transom	75	–	55.3
Outboard mounting locknuts and bolts - metal lift plates and setback brackets	122	–	90

- Check corrosion control anodes. Check more frequently when used in saltwater. Refer to **Corrosion Control Anodes**.
- Drain and replace gearcase lubricant. Refer to **Gearcase Lubrication**.
- Inspect battery. Refer to **Battery Inspection**.
- Saltwater usage: Remove and inspect spark plugs for corrosion and replace as necessary. Apply Anti-Seize Compound only on threads of spark plug prior to installation. Refer to **Spark Plug Inspection and Replacement**.

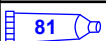
Tube Ref No.	Description	Where Used	Part No.
 81	Anti-Seize Compound	Spark plug threads	92-898101389

- Check tightness of bolts, nuts, and other fasteners—dealer service.
- Add Quickleen to the fuel tank.

Tube Ref No.	Description	Where Used	Part No.
	Quickleen Engine & Fuel System Cleaner	Fuel tank	8M0047931

- Check cowl seals to ensure seals are intact and not damaged.
- Check that the intake silencer is in place, if equipped.
- Check that the idle relief muffler is in place, if equipped.

MAINTENANCE

- Check for loose hose clamps and rubber boots on the air intake assembly, if equipped.

EVERY 300 HOURS OF USE OR THREE YEARS

- Check power trim fluid. Refer to **Checking Power Trim Fluid**.
- Lubricate all lubrication points. Lubricate more frequently when used in saltwater. Refer to **Lubrication Points**.
- Replace water pump impeller—dealer service.¹
- Lubricate the splines on the upper driveshaft—dealer service.
- Check wiring and connectors—dealer service.
- Replace alternator drive belt. Refer to **Alternator Drive Belt**—dealer service.
- Replace the spark plugs.









BEFORE PERIODS OF STORAGE

- Refer to **Storage** section.

Maintenance Schedule Decals



MAINTENANCE SCHEDULE DECAL ICONS

A maintenance schedule decal is located on the engine to remind the owner or operator when the power package important maintenance items require attention. The following table shows the icons and a general description of the scheduled maintenance items.

Icon	Definition	Icon	Definition
 58249	Replace	 58250	Inspect
 58251	Engine oil and filter	 58252	Gearcase lubricant
 58253	Spark plugs	 58254	Thermostat
 58255	Low-pressure fuel filter	 58256	Anodes













1. Replace the water pump impeller more often if overheating occurs or reduced water pressure is noted.

MAINTENANCE

Icon	Definition	Icon	Definition
 58257	Accessory drive belt	 58258	Water pump impeller

V6 FOURSTROKE MODELS MAINTENANCE SCHEDULE DECAL

MAINTENANCE SCHEDULE
FOURSTROKE

EVERY 100 HOURS OF USE OR ONCE YEARLY	EVERY 300 HOURS OF USE OR THREE YEARS
↕ REPLACE	↕ REPLACE
 Engine Oil and Filter	 Spark Plugs*
 Gearcase Lubricant	 Low Pressure Fuel Filter
INSPECT	 Accessory Drive Belt
 Anodes	 Water Pump Impeller
 Thermostat	
 Spark Plugs*	
 Low Pressure Fuel Filter	For additional maintenance and storage preparation see Owner's Manual

Specifications



Full Throttle RPM: 175/200HP: 5000-5800
225HP: 5200-6000

Neutral Idle RPM: 600

 *In Saltwater:
Apply Anti-Seize
20 Nm (15 lb-ft)

8M0135348
0.9 mm (0.035 in.)

 Engine Oil
6.6 L (7.0 U.S. qt.)

64026

MAINTENANCE

V6 PRO XS MODELS MAINTENANCE SCHEDULE DECAL

MAINTENANCE SCHEDULE

EVERY 100 HOURS OF USE OR ONCE YEARLY	EVERY 300 HOURS OF USE OR THREE YEARS
REPLACE	REPLACE
<ul style="list-style-type: none"> Engine Oil and Filter Gearcase Lubricant INSPECT Anodes Thermostat Spark Plugs* Low Pressure Fuel Filter 	<ul style="list-style-type: none"> Spark Plugs* Low Pressure Fuel Filter Accessory Drive Belt Water Pump Impeller
<p>For additional maintenance and storage preparation see Owner's Manual</p>	
Specifications	
Full Throttle RPM: 5400-6000 Neutral Idle RPM: 600	
	*In Saltwater: Apply Anti-Seize 20 Nm (15 lb-ft) 8M0135348 0.9 mm (0.035 in.)
Engine Oil 6.6 L (7.0 U.S. qt.) 	

64041

SEAPRO V6 MODELS MAINTENANCE SCHEDULE DECAL

COMMERCIAL MAINTENANCE SCHEDULE

EVERY 100 HOURS	EVERY 300 HOURS
REPLACE	REPLACE
<ul style="list-style-type: none"> Engine Oil and Filter Gearcase Lubricant INSPECT Anodes Thermostat Spark Plugs* Low Pressure Fuel Filter 	<ul style="list-style-type: none"> Spark Plugs* Low Pressure Fuel Filter Accessory Drive Belt Water Pump Impeller
<p>For additional maintenance and storage preparation see Owner's Manual</p>	
Specifications	
Full Throttle RPM: 4800-5400 Neutral Idle RPM: 600 Valve Lash: Inspect Every 1000 Hrs	
	*In Saltwater: Apply Anti-Seize 20 Nm (15 lb-ft) 8M0135348 0.9 mm (0.035 in.)
Engine Oil 6.6 L (7.0 U.S. qt.) 	

64042

MAINTENANCE

V8 FOURSTROKE MODELS MAINTENANCE SCHEDULE DECAL

MAINTENANCE SCHEDULE	
FOURSTROKE	
EVERY 100 HOURS OF USE OR ONCE YEARLY	EVERY 300 HOURS OF USE OR THREE YEARS
↔ REPLACE	↔ REPLACE
Engine Oil and Filter Gearcase Lubricant	Spark Plugs* Low Pressure Fuel Filter
✓ INSPECT	
Anodes Thermostat Spark Plugs*	Accessory Drive Belt Water Pump Impeller
Low Pressure Fuel Filter	
For additional maintenance and storage preparation see Owner's Manual	
Specifications	
Full Throttle RPM: 5200-6000 Neutral Idle RPM: 600	* In Saltwater: Apply Anti-Seize 20 Nm (15 lb-ft) 8M0135348 0.9 mm (0.035 in.)
	Engine Oil 6.6 L (7.0 U.S. qt.)

64043

V8 PRO XS MODELS MAINTENANCE SCHEDULE DECAL

MAINTENANCE SCHEDULE	
PRO XS	
EVERY 100 HOURS OF USE OR ONCE YEARLY	EVERY 300 HOURS OF USE OR THREE YEARS
↔ REPLACE	↔ REPLACE
Engine Oil and Filter Gearcase Lubricant	Spark Plugs* Low Pressure Fuel Filter
✓ INSPECT	
Anodes Thermostat Spark Plugs*	Accessory Drive Belt Water Pump Impeller
Low Pressure Fuel Filter	
For additional maintenance and storage preparation see Owner's Manual	
Specifications	
Full Throttle RPM: 5600-6200 Neutral Idle RPM: 600	* In Saltwater: Apply Anti-Seize 20 Nm (15 lb-ft) 8M0135348 0.9 mm (0.035 in.)
	Engine Oil 6.6 L (7.0 U.S. qt.)

64044

MAINTENANCE

SEAPRO V8 MODELS MAINTENANCE SCHEDULE DECAL

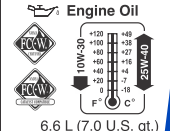
COMMERCIAL MAINTENANCE SCHEDULE	
EVERY 100 HOURS	EVERY 300 HOURS
REPLACE	REPLACE
<ul style="list-style-type: none"> Engine Oil and Filter Gearcase Lubricant 	<ul style="list-style-type: none"> Spark Plugs* Low Pressure Fuel Filter
INSPECT	
<ul style="list-style-type: none"> Anodes Thermostat Spark Plugs* 	<ul style="list-style-type: none"> Accessory Drive Belt Water Pump Impeller
Low Pressure Fuel Filter	
For additional maintenance and storage preparation see Owner's Manual	
Specifications	
Full Throttle RPM: 4800-5600 Neutral Idle RPM: 600 Valve Lash: Inspect Every 1000 Hrs	 <p>* In Saltwater: Apply Anti-Seize 20 Nm (15 lb-ft) 8M0135348 0.9 mm (0.035 in.)</p>
	 <p>Engine Oil 6.6 L (7.0 U.S. qt.)</p>

64045

250R AND 300R MODELS MAINTENANCE SCHEDULE DECAL

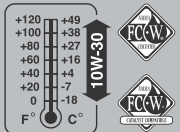
MERCURY RACING		Specifications
MAINTENANCE SCHEDULE		
EVERY 100 HOURS OF USE OR ONCE YEARLY		
REPLACE	<ul style="list-style-type: none"> Engine Oil And Filter Gearcase Lubricant 	Full Throttle RPM 250R: 5600-6200 300R: 5800-6400 Neutral Idle RPM: 600
INSPECT	<ul style="list-style-type: none"> Anodes Thermostat Spark Plugs* Low Pressure Fuel Filter 	Spark Plug: 8M0135348 Gap: 0.9 mm (0.035 in.) Torque: 20 Nm (15 lb-ft)
		* In Saltwater: Apply Anti-Seize Compound To Thread
EVERY 300 HOURS OF USE OR THREE YEARS		
REPLACE	<ul style="list-style-type: none"> Spark Plugs* Low Pressure Fuel Filter Accessory Drive Belt Water Pump Impeller 	 <p>Engine Oil 6.6 L (7.0 U.S. qt.)</p>
For additional maintenance and storage preparation see Owner's Manual		

65585

MAINTENANCE

Flushing the Cooling System

Flush the internal water passages of the outboard with fresh water after each use in salt, polluted, or muddy water. This will help prevent a buildup of deposits from clogging the internal water passages.

NOTE: *The outboard can be tilted or in the vertical operating position during flushing.*

1. With the engine turned off, place the outboard in either the operating position (vertical) or in a tilted position.
2. Remove the flush connector from the bottom cowl.
3. Remove the cover from the flush connector and thread a water hose into the flush connector.

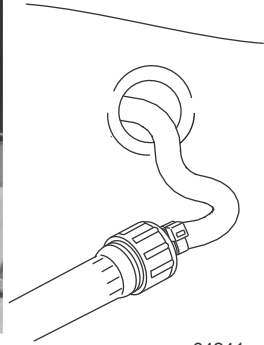
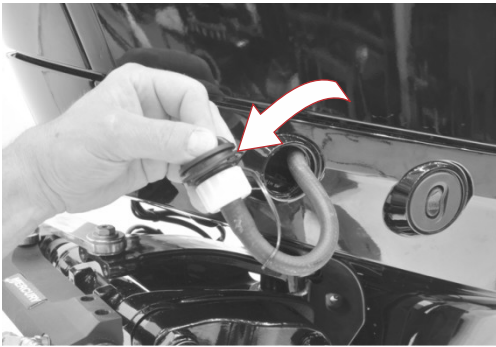

64241

4. Turn on the water tap (1/2 maximum) and let the water flush through the cooling system for about 15 minutes.
5. When flushing is complete, turn off the water and disconnect the water hose.
6. Install the cover on the flush connector. Place the flush connector back into the bottom cowl.

Top Cowl Removal and Installation

NOTE: *It is recommended to remove and install the cowl while standing inside the boat.*

REMOVAL

1. Tilt the outboard up so the top of the cowl is facing up.

MAINTENANCE

2. Push down on the port side of the service access door to unlock and open the door.

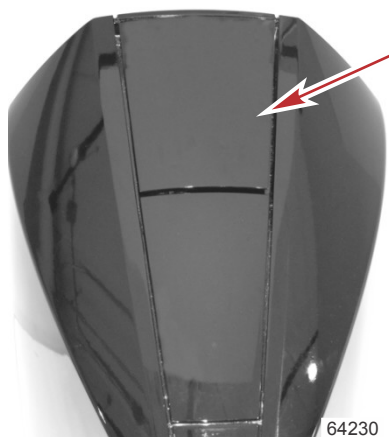

Push here to unlock

3. Press on the red lock button and lift the handle.



- a** - Service access door
- b** - Red lock button
- c** - Handle

MAINTENANCE

4. Push the handle towards the aft to lock the handle into the cowl lift position.



Handle locked in the lift position

5. With a firm grip on the handle, carefully lift the cowl off the engine.

INSTALLATION

1. With a firm grip on the handle, carefully lower the top cowl over the engine.
2. Verify the cowl is correctly aligned by checking the cowl alignment guides on the port and starboard side of the cowl. If there is misalignment, one side of the cowl will have a gap that is larger than the other side.

NOTE: *It may be necessary to slightly lift the larger gap side of the cowl to correctly position the alignment guides.*

3. Gently push down on the cowl.
4. Push the red lock button and pull the handle. Continue to push the handle down into the locked position.
5. Close the service access door.

Battery Inspection

The battery should be inspected at periodic intervals to ensure proper engine starting capability.

IMPORTANT: Read the safety and maintenance instructions which accompany your battery.

1. Turn off the engine before servicing the battery.
2. Ensure the battery is secure against movement.

MAINTENANCE

3. Battery cable terminals should be clean, tight, and correctly installed. Positive to positive and negative to negative.
4. Ensure the battery is equipped with a nonconductive shield to prevent accidental shorting of battery terminals.

Battery Cables and Clean Power Harness

The battery cable connections should be checked often for corrosion or loose retaining hardware. Maintaining this electrical connection helps ensure the engine operation and accessories functionality remains trouble-free. The engine starting battery cables and the clean power harness wires must be secured to the engine starting battery with nuts. Wing nuts are not acceptable. The clean power harness must be secured to one of the battery cables with a cable tie or other type of secure fastener.

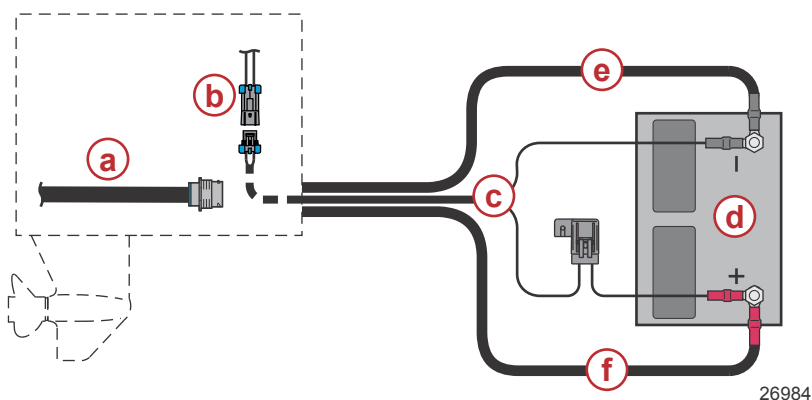

- a - 14-pin data harness
- b - Clean power harness connector at engine
- c - Clean power harness
- d - Battery
- e - Negative engine battery cable
- f - Positive engine battery cable

If the clean power harness fuse is open, try to locate and correct the cause of the overload. If the cause is not found, the fuse may open again. Remove the clean power fuse and look at the silver band inside the fuse. If the band is broken (open), replace the fuse with the same rating (5 amp) and type fuse.

MAINTENANCE

IMPORTANT: An ATC fuse has the fuse element enclosed or sealed inside the plastic housing. This type of fuse must be used for marine applications. Marine applications are exposed to environments that may have the potential to accumulate explosive vapors. ATO fuses have exposed elements and should never be used in marine applications.

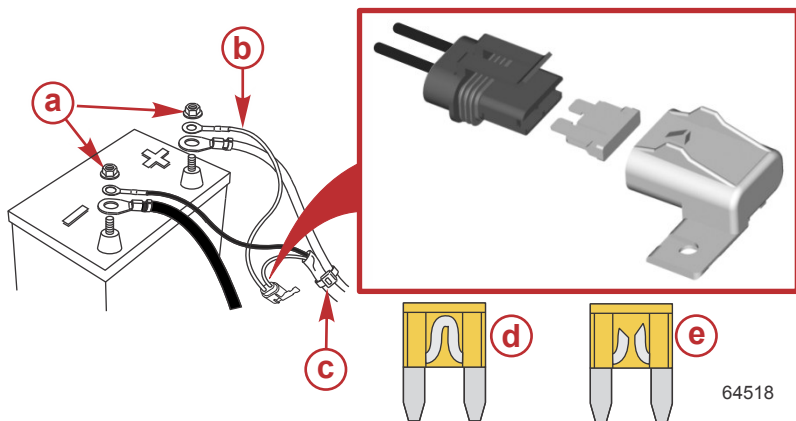

- a - Nuts
- b - Clean power harness
- c - Cable tie
- d - Good fuse
- e - Open fuse

BATTERY CONNECTIONS

IMPORTANT: The engine electrical system is negative (-) ground.

When connecting the engine battery, hex nuts must be used to secure the battery leads to the battery posts. Tighten the hex nuts to the specified torque.

Description	Nm	lb-in.	lb-ft
Battery hex nuts	13.5	120	-

ORDER OF CONNECTION

Connect the battery cables in the following order:

1. All jumpers between parallel, multiple battery packs
2. From the batteries to the positive (+) engine lead
3. From the batteries to the positive (+) clean power
4. From the batteries to the negative (-) engine lead
5. From the batteries to the negative (-) clean power
6. From the batteries or main ground (-) bus to the negative (-) starboard helm main power relay

MAINTENANCE

Fuel System

WARNING

Fuel is flammable and explosive. Ensure that the key switch is OFF and the lanyard is positioned so that the engine cannot start. Do not smoke or allow sources of spark or open flame in the area while servicing. Keep the work area well ventilated and avoid prolonged exposure to vapors. Always check for leaks before attempting to start the engine, and wipe up any spilled fuel immediately.

IMPORTANT: Use an approved container to collect and store fuel. Wipe up spilled fuel immediately. Material used to contain spilled fuel must be disposed of in an approved receptacle.

Before servicing any part of the fuel system:

1. Stop engine and disconnect the battery.
2. Perform fuel system service in a well-ventilated area.
3. Inspect any completed service work for sign of fuel leakage.

FUEL LINE INSPECTION

Visually inspect the fuel line for cracks, swelling, leaks, hardness, or other signs of deterioration or damage. If any of these conditions are found, the fuel line must be replaced.

LOW-PRESSURE FUEL FILTER

The low-pressure fuel filter can be serviced as a general maintenance item when the water-in-fuel alarm is activated.

WARNING

Fuel is flammable and explosive. Ensure that the key switch is OFF and the lanyard is positioned so that the engine cannot start. Do not smoke or allow sources of spark or open flame in the area while servicing. Keep the work area well ventilated and avoid prolonged exposure to vapors. Always check for leaks before attempting to start the engine, and wipe up any spilled fuel immediately.

Removal

IMPORTANT: Use an approved container to collect and store fuel. Wipe up spilled fuel immediately. Material used to contain spilled fuel must be disposed of in an approved container.

1. Verify the ignition key switch is in the OFF position and that the lanyard switch is positioned so the engine cannot start.
2. Remove the top cowl.
3. Locate the fuel filter on the starboard aft side of the engine near the bottom spark plug.

MAINTENANCE

4. Push in on the fuel hose release tabs and disconnect the fuel hoses from the fuel filter.
5. Disconnect the water-in-fuel sensor harness.

NOTE: If there is a boat mounted water-separating fuel filter with a water-in-fuel sensor installed, the sensor harness would be connected to the boat mounted filter.

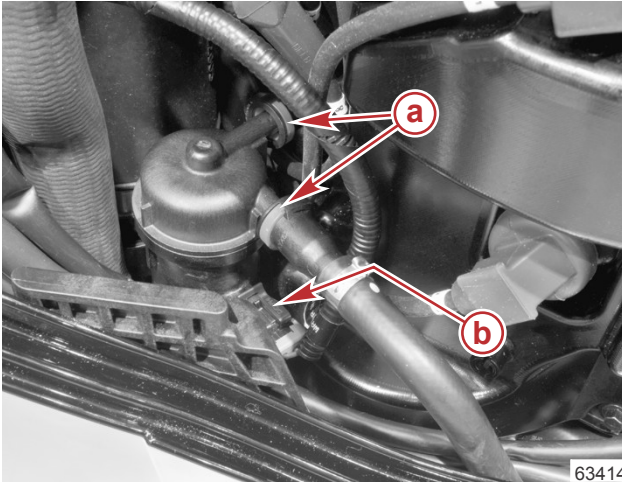

- a** - Fuel hose release tabs
- b** - Water-in-fuel sensor harness

6. Rotate the filter clockwise approximately 1/4 of a turn and lift the filter out.

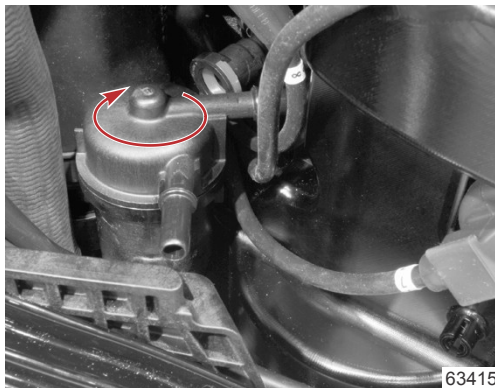

Filter rotated 1/4 turn

7. Empty the fuel filter contents into an approved container and dispose according to local regulations.

MAINTENANCE

8. Wipe up any spilled fuel.

Installation

1. Apply a small amount of 2-4-C with PTFE to the fuel filter grommet.

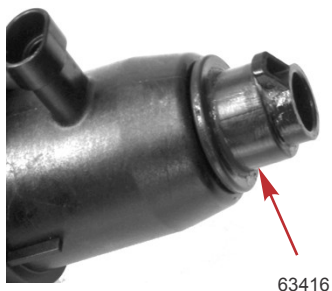

Tube Ref No.	Description	Where Used	Part No.
 95	2-4-C with PTFE	Fuel filter grommet	92-802859A 1

2. Install the fuel filter and rotate counterclockwise 1/4 turn to retain the filter.
3. Connect the water-in-fuel sensor harness.

NOTE: *If there is a boat mounted water-separating fuel filter with a water-in-fuel sensor installed, the sensor harness would be connected to the boat mounted filter.*

4. Connect the fuel hoses to the fuel filter securely with the locking hose connections.
5. Turn the key to the RUN position and inspect for fuel leaks. Repair any fuel leaks if necessary.

Corrosion Control Anode

The outboard has corrosion control anodes at different locations. An anode helps protect the outboard against galvanic corrosion by sacrificing its metal to be slowly eroded instead of the outboard metals.

Each anode requires periodic inspection, especially in saltwater which will accelerate the erosion. To maintain this corrosion protection, always replace the anode before it is 50% eroded. Never paint or apply a protective coating on the anode as this will reduce effectiveness of the anode.

MAINTENANCE

Two anodes are located on the engine; one anode is on the gear housing and the other is on the bottom of the transom bracket assembly.

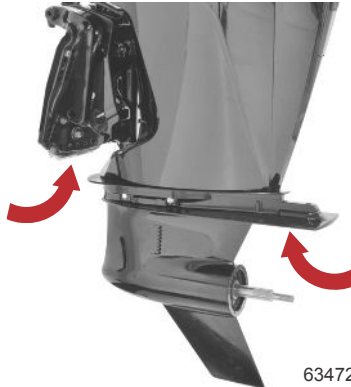

Propeller Replacement

⚠ WARNING

Rotating propellers can cause serious injury or death. Never operate the boat out of the water with a propeller installed. Before installing or removing a propeller, place the drive unit in neutral and activate the lanyard stop switch to prevent the engine from starting. Place a block of wood between the propeller blade and the anti-ventilation plate.

1. Shift outboard to the neutral (N) position.



2. Remove the key from the ignition.
3. Straighten the bent tabs on the propeller nut retainer.

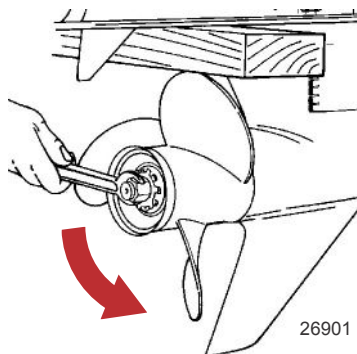

MAINTENANCE

- Place a block of wood between the gearcase and the propeller to hold the propeller and remove the propeller nut.

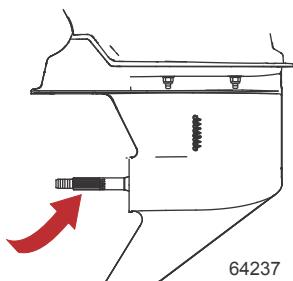

- Pull the propeller straight off the shaft. If the propeller is seized to the shaft and cannot be removed, have the propeller removed by an authorized dealer.
- Apply a liberal amount of Extreme Grease or 2-4-C with PTFE to the propeller shaft.



Tube Ref No.	Description	Where Used	Part No.
	Extreme Grease	Propeller shaft	8M0071842
	2-4-C with PTFE	Propeller shaft	92-802859A 1

IMPORTANT: To prevent the propeller hub from corroding and seizing to the propeller shaft, especially in saltwater, always apply a liberal amount of the recommended lubricant to the entire propeller shaft at the recommended maintenance intervals and also each time the propeller is removed.

MAINTENANCE

FLO-TORQ II PROPELLER HUB KIT—25.4 MM (1 IN.) PROPELLER SHAFT

1. Install the propeller onto the shaft with the supplied components as shown.
2. Place the locknut retainer over the raised pins on the drive sleeve adapter and tighten the locknut to the specified torque.
3. Secure the locknut by bending the tabs up against the locknuts.

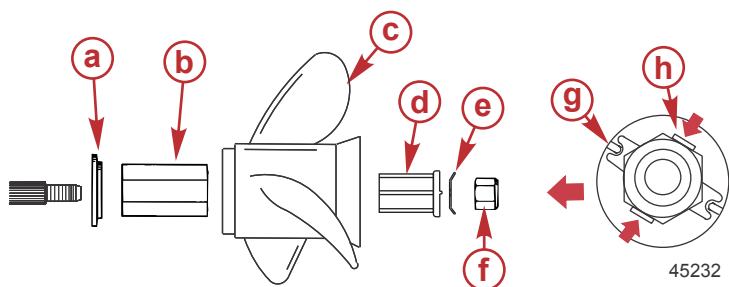

- a** - Forward thrust washer
- b** - Drive sleeve
- c** - Propeller
- d** - Drive sleeve adapter
- e** - Locknut retainer
- f** - Locknut
- g** - Raised pins
- h** - Tabs bent against the locknut

Description	Nm	lb-in.	lb-ft
Locknut	75	–	55.3

FLO-TORQ IV PROPELLER HUB KIT—25.4 MM (1 IN.) PROPELLER SHAFT

1. Install the propeller onto the shaft with the supplied components as shown.
2. Tighten the locknut to the specified torque.

MAINTENANCE

- Secure the locknut by bending three of the tabs into the grooves in the drive sleeve adapter.

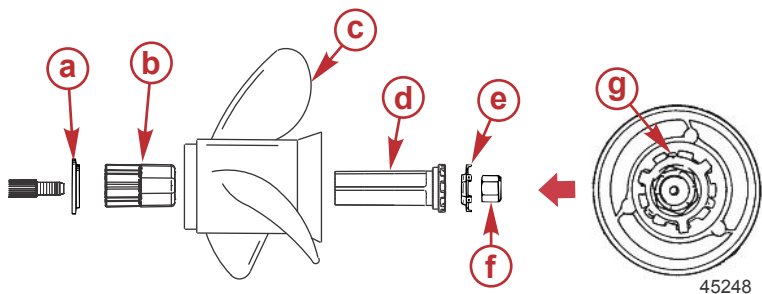

- a - Forward thrust washer
- b - Drive sleeve
- c - Propeller
- d - Drive sleeve adapter
- e - Locknut retainer
- f - Locknut
- g - Tabs bent into grooves

Description	Nm	lb-in.	lb-ft
Locknut	75	–	55.3

SSR PROPELLER HUB KIT—25.4 MM (1 IN.) PROPELLER SHAFT

IMPORTANT: The SSR was designed for use with only the 8 spline aft drive sleeve adapter—8M0109703. The use of any other aft drive sleeve adapter may result in a premature failure of the SSR hub and an increase in propeller vibration and noise.

NOTE: The Flo-Torq SSR hub is designed to have a small amount of free play when installed. This free play helps the SSR dampen the noise and vibration of the propeller. The propeller may move in and out up to 0.3175 cm (1/8 inch) and rotate up to 10 degrees when correctly installed.

MAINTENANCE

1. Assemble the hub components and propeller as shown:

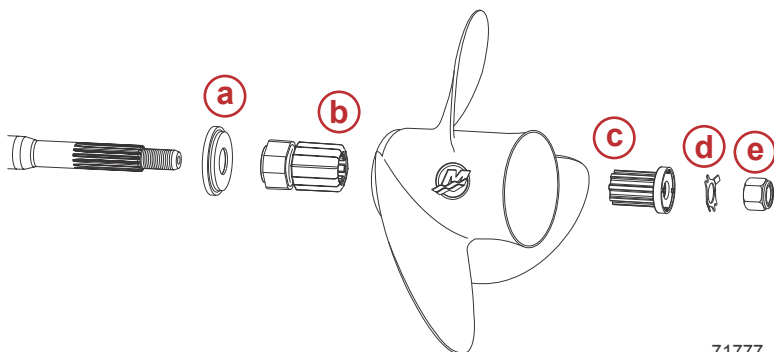

71777

- a** - Thrust washer
- b** - Drive sleeve
- c** - Drive sleeve adapter
- d** - Tabbed locknut washer
- e** - Locknut

2. Tighten the locknut to the specified torque.

Description	Nm	lb-in.	lb-ft
Locknut	135	–	100

3. Bend the locking tabs on the tabbed locknut washer against the sides of the locknut.

NOTE: If the tabbed locknut washer does not line up with the flat sides of the locknut, loosen the locknut, rotate the washer 90 degrees, and tighten the locknut to specified torque.

MAINTENANCE

SSR SOLID PROPELLER HUB KIT—25.4 MM (1 IN.) PROPELLER SHAFT

1. Assemble the hub components and propeller as shown:

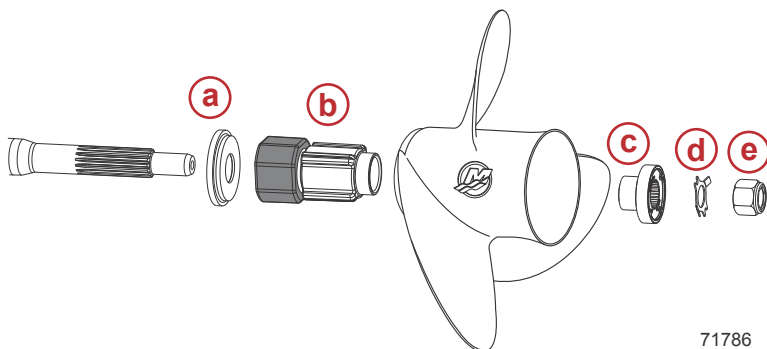

- a - Thrust washer
- b - Solid hub with fused rubber sleeve
- c - Drive sleeve adapter
- d - Tabbed locknut washer
- e - Locknut

2. Tighten the locknut to the specified torque.

Description	Nm	lb-in.	lb-ft
Locknut	74.6	—	55

3. Bend the locking tabs on the tabbed locknut washer against the sides of the locknut.

Propeller Replacement—31.75 mm (1-1/4 in.) Diameter Propeller Shaft

⚠ WARNING

Rotating propellers can cause serious injury or death. Never operate the boat out of the water with a propeller installed. Before installing or removing a propeller, place the drive unit in neutral and activate the lanyard stop switch to prevent the engine from starting. Place a block of wood between the propeller blade and the anti-ventilation plate.



1. Shift the outboard into neutral position.

MAINTENANCE

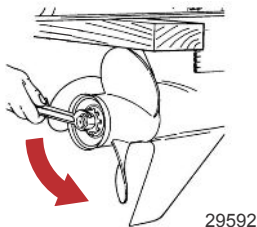
- Place a block of wood between the gearcase and the propeller to hold the propeller and remove the propeller nut.



- Pull the propeller straight off the shaft. If the propeller is seized to the shaft and cannot be removed, have the propeller removed by an authorized dealer.
- To aid in future removal of the propeller, liberally coat the propeller shaft splines with one of the following Mercury/Quicksilver products:

Tube Ref No.	Description	Where Used	Part No.
	Extreme Grease	Propeller shaft splines	8M0071842
 95	2-4-C with PTFE	Propeller shaft splines	92-802859A 1

NOTE: Propellers used on the 31.75 mm (1-1/4 in.) diameter propeller shaft require the heavy-duty propeller hub kit.

- Heavy-duty propeller hub**—Install the propeller hub, propeller, washer, Belleville washer, washer, and propeller nut onto the shaft.

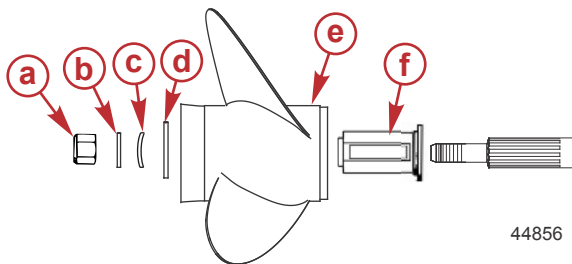

- a** - Propeller nut
- b** - Washer
- c** - Belleville washer
- d** - Washer
- e** - Propeller
- f** - Propeller hub

MAINTENANCE

- Place a block of wood between the gearcase and the propeller. Tighten the propeller nut to the specified torque.

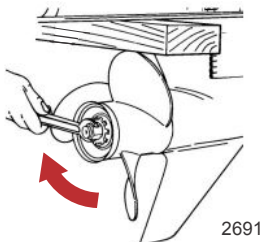

Description	Nm	lb-in.	lb-ft
Propeller nut	75	–	55.3

Spark Plug Inspection and Replacement

- Remove the top cowl. Refer to **Top Cowl Removal and Installation**.
- Grasp the spark plug boot and use a twisting motion to assist removing the spark plug boot from the spark plugs.

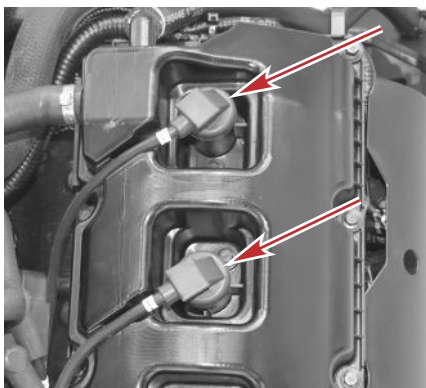

Spark plug boot

- Remove the spark plug with a 14 mm deep socket.

NOTE: Replace the spark plug if the electrode is worn; the insulator is rough, cracked, broken, or blistered; or if the precious metal is not visible on the spark plug electrode.

MAINTENANCE

IMPORTANT: The color of the plug may not accurately reflect its condition. To accurately diagnose a faulty plug, inspect the precious metal on the plug's electrode. If no precious metal is visible, replace the plug.

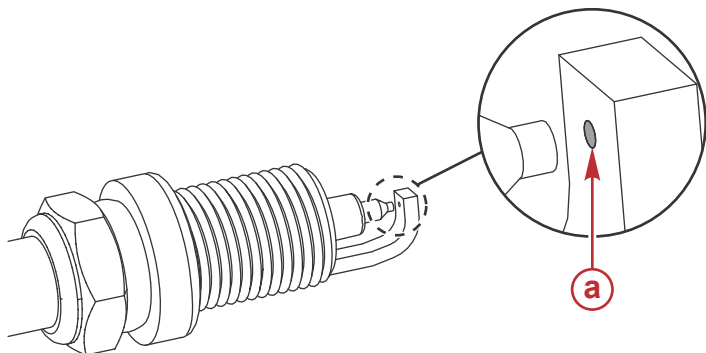

9381

a - Precious metal

4. Check the spark plug gap. Refer to **General Information - Specification**.

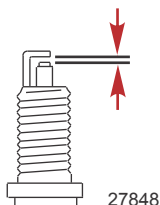

- a. All of the spark plugs should have the gap checked and corrected as necessary before installation.
 - b. Measure the gap with a feeler gauge or pin gauge. Never use a wedge-type gap checking tool to inspect or to adjust the gap.
 - c. If an adjustment is necessary, do not pry or apply any force on the center electrode. This is critical with any type of spark plug that has a wear surface, such as platinum or iridium added to either the ground electrode or the center electrode.
 - d. When it is necessary to widen the gap, use a tool that only pulls back on the ground electrode without touching the center electrode, the porcelain, or the wear portion of the ground electrode.
 - e. When it is necessary to close the gap, gently tap the plug ground electrode on a hard surface.
5. Saltwater use—Apply Anti-Seize Compound only onto the threads of the spark plugs.

MAINTENANCE

Tube Ref No.	Description	Where Used	Part No.
 81	Anti-Seize Compound	Spark plug threads	92-898101389

6. Before installing the spark plugs, remove any dirt on the spark plug seat area. Install the plugs finger-tight and then tighten an additional 1/4 turn or tighten to the specified torque.

Description	Nm	lb-in.	lb-ft
Spark plug	20	177	–

7. Insert the spark plug boot into the valve cover. The boot is self-aligning with the spark plug.
8. Push on the end of the spark plug boot to ensure the boot is completely engaged and seated onto the spark plug.



63315

Push the spark plug boot

9. Install the top cowl.

Fuses

IMPORTANT: An ATC fuse has the fuse element enclosed or sealed inside the plastic housing. This type of fuse must be used for marine applications. Marine applications are exposed to environments that may have the potential to accumulate explosive vapors. ATO fuses have exposed elements and should never be used in marine applications.

The electrical wiring circuits on the outboard are protected from overload with fuses. If a fuse is open, try to locate and correct the cause of the overload. If the cause is not found, the fuse may open again.

MAINTENANCE

1. Locate the fuse holder on the port side of the engine and remove the cover from the fuse holder.

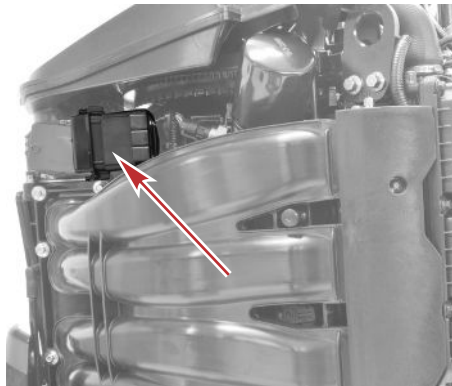

63317

2. Remove the suspected open fuse and look at the silver band inside the fuse. If the band is broken (open), replace the fuse.

MAINTENANCE

IMPORTANT: Replace the fuse with a new fuse with the same amp rating.

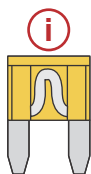
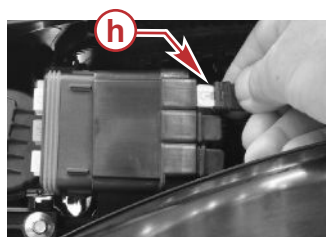
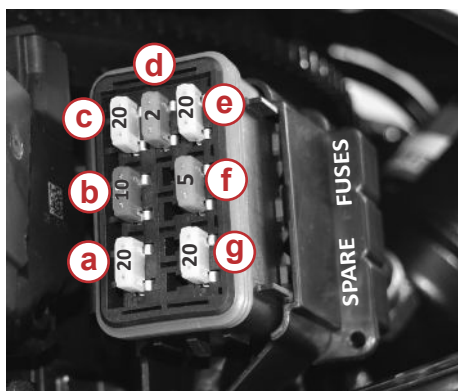

63805

- a** - Ignition coils - 20 amp
- b** - Oxygen sensor - 10 amp
- c** - Fuel pumps - 20 amp
- d** - Diagnostics - 2 amp
- e** - Fuel injectors - 20 amp
- f** - Advanced sound control driver - 5 amp
- g** - Power driver - 20 amp
- h** - Spare fuses (3)
- i** - Good fuse
- j** - Open fuse

Alternator Drive Belt

The alternator drive belt is located under the flywheel shroud–intake air induction plenum. The alternator drive belt inspection must be completed by an authorized Mercury dealer at the recommended interval. Refer to **Inspection and Maintenance Schedule**.

Lubrication Points

1. Lubricate the following with Extreme Grease or 2-4-C with PTFE.

Tube Ref No.	Description	Where Used	Part No.
	Extreme Grease	Swivel bracket, tilt lock, propeller shaft	8M0071842

MAINTENANCE

Tube Ref No.	Description	Where Used	Part No.
 95	2-4-C with PTFE	Swivel bracket, tilt lock, tilt tube, propeller shaft	92-802859A 1

- Lubricate the swivel bracket and tilt lock through the grease fittings.

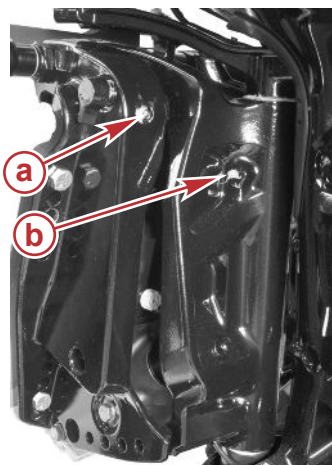

- a** - Tilt lock grease fitting
- b** - Swivel bracket grease fitting

63792

- Lubricate the tilt tube through the grease fitting.

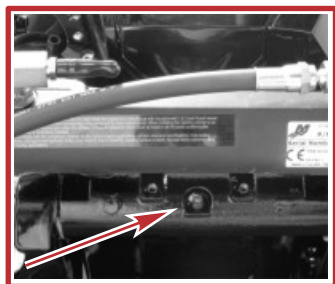

64517

MAINTENANCE

- Propeller shaft—Refer to **Propeller Replacement** for removal and installation of the propeller. Apply a generous amount of lubricant to the entire propeller shaft to prevent the propeller hub from seizing to the shaft.

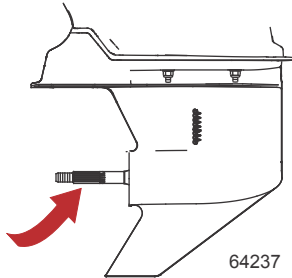

2. Lubricate the steering linkage with oil.

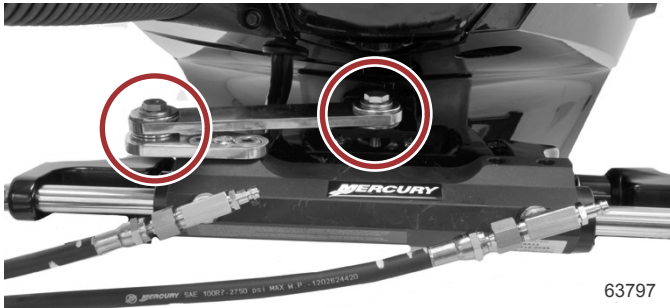

Lubricate with oil

Checking Power Trim Fluid

1. Tilt the outboard to the full up position and engage the tilt support lever.

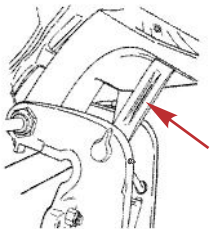

MAINTENANCE

2. Remove the fill cap and check the fluid level. The fluid level should be even with the bottom of the fill hole. Add Quicksilver or Mercury Precision Lubricant Power Trim and Steering Fluid. If not available, use automotive automatic transmission fluid (ATF).

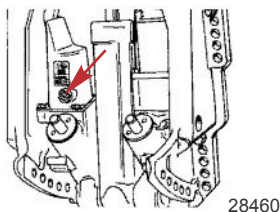

Tube Ref No.	Description	Where Used	Part No.
 114	Power Trim and Steering Fluid	Power trim system	92-858074K01

Checking Hydraulic Steering Fluid

WARNING

Dirt or contaminants in the hydraulic steering system can damage the steering system's internal components. Damaged components can lead to serious injury or death due to loss of boat control. Do not allow dirt or contamination to enter the helm, lines, or cylinder of this steering system and perform all hydraulic inspections, service, or assembly procedures in a clean work area.

IMPORTANT: Check the hydraulic steering fluid level on a regular basis. The steering system must be full of fluid to ensure the steering helm will not introduce air into the steering system. A hydraulic steering system which has entrained air will have spongy or unresponsive steering control which could compromise the operator's ability to control the boat. On dual helm steering systems, always check the upper steering helm first. If the system must be purged of entrained air, one person may not be able to completely fill and purge the air from the steering system. See your dealer if you have questions on your steering system or refer to the installation instructions included with your steering system.

MAINTENANCE

Checking Power Steering Fluid

⚠ WARNING

Dirt or contaminants in the hydraulic steering system can damage the steering system's internal components. Damaged components can lead to serious injury or death due to loss of boat control. Do not allow dirt or contamination to enter the helm, lines, or cylinder of this steering system and perform all hydraulic inspections, service, or assembly procedures in a clean work area.

Remove the power steering cover and fill cap to check the fluid level. The fluid level should be slightly below the bottom of the fill hole. Use Synthetic Power Steering Fluid SAE 0W-30, if needed.

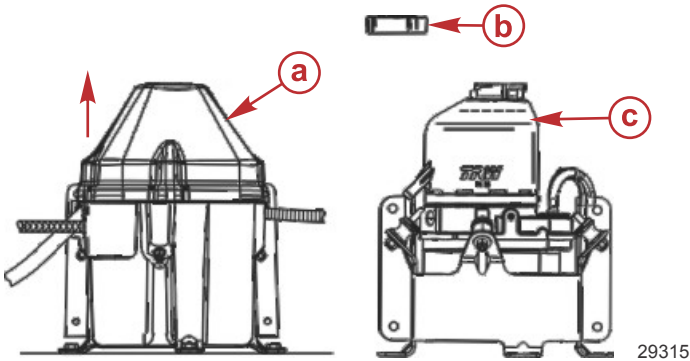

- a - Power steering cover
- b - Fill cap
- c - Fill/full level

Tube Ref No.	Description	Where Used	Part No.
 138	Synthetic Power Steering Fluid SAE 0W-30	Power steering system	92-858077K01

Changing Engine Oil and Filter

ENGINE OIL CAPACITY

Engine oil capacity is approximately 6.6 liter (7.0 US qt).

IMPORTANT: Tilt the outboard out/up past vertical for approximately one minute to allow any trapped oil to drain back to the oil sump.

MAINTENANCE

OIL CHANGE ON LAND

1. Tilt the outboard out/up past vertical for approximately one minute to allow any trapped oil to drain back to the oil sump.
2. Tilt the outboard down to the vertical position.
3. Use a 16 mm (5/8 in.) wrench to loosen the oil drain valve just enough so that it can be turned by hand. Do not to open the valve so far as to allow oil to drain.
4. Attach a 12 mm (7/16 in.) inside diameter drain hose to the oil drain valve. Position the opposite end of the hose into an appropriate container. The container should be large enough to hold more than 9.8 liter (10 US qt).

IMPORTANT: Do not loosen the oil drain valve more than 2-1/2 turns. The oil seal could get damaged beyond 2-1/2 turns.

5. Loosen the oil drain valve 2-1/2 turns to allow oil to drain. Do not exceed 2-1/2 turns.

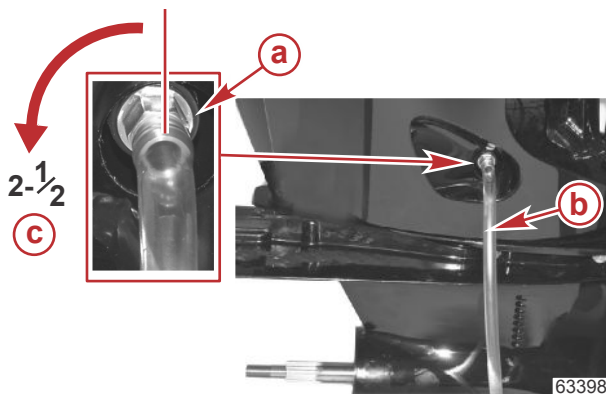

- a - Oil drain valve
- b - Drain hose
- c - Loosen 2-1/2 turns maximum

6. After the oil has drained, hand-tighten the oil drain valve (clockwise) and remove the oil drain hose.

IMPORTANT: Overtightening the oil drain valve can damage the oil sump.

7. Tighten the oil drain valve to the specified torque. Clean up any oil in the valve area.

Description	Nm	lb-in.	lb-ft
Oil drain valve	15	132.7	-

8. Add the appropriate amount of engine oil.

MAINTENANCE

OIL CHANGE ON WATER

1. Tilt the outboard out/up past vertical for approximately one minute to allow any trapped oil to drain back to the oil sump.
2. Tilt the outboard to a vertical position.
3. Push down on the port side of the service access door to unlock and open the door.

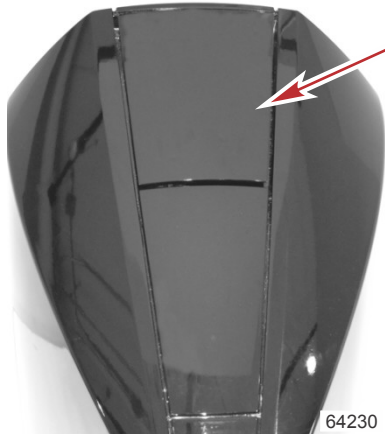



Push here to unlock

4. Remove the dipstick.
5. Install the oil drain hose onto the crankcase oil pump. Verify the hose is securely attached.



- a** - Crankcase oil pump
- b** - Oil drain hose

MAINTENANCE

Crankcase Oil Pump	802889A1
 <p>11591</p>	Aids in the removal of engine oil without draining the crankcase.
Oil Drain Hose	8M0129230
 <p>64627</p>	Aids in the removal of engine oil without draining the crankcase. Connect to the crankcase oil pump.

6. Install the crankcase oil pump assembly onto the dipstick tube. Verify the pump is securely attached to the tube by pulling it up lightly.

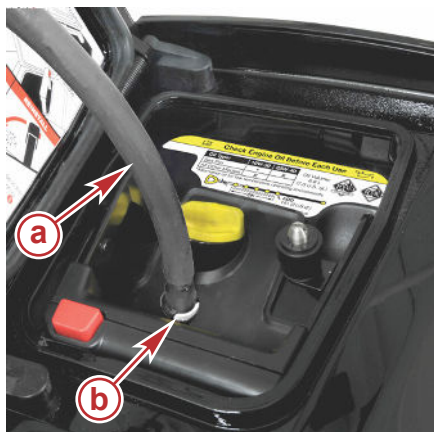

- a - Oil drain hose
- b - Lock button

63843

7. Place the drain tube of the crankcase oil pump into an appropriate container. The container should be large enough to hold more than 9.8 liter (10 US qt).
8. Extract the engine oil with the pump.
9. Allow the drain tube to completely drain before removing the oil pump from the dipstick tube.
10. Press on the oil drain hose lock button to release it from the dipstick tube.

MAINTENANCE

11. Install the dipstick. Verify it is completely inserted.
12. Add the appropriate amount of engine oil.

CHANGING OIL FILTER

1. Remove the plug from the oil trough and attach a 12 mm (7/16 in.) I.D. drain hose to the fitting. Place the opposite end of the hose into an appropriate container.
2. Remove the old filter by turning the filter counterclockwise.

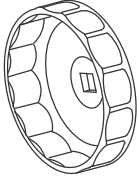
Oil Filter Wrench	91-889277
 5221	Aids in the removal of the oil filter.

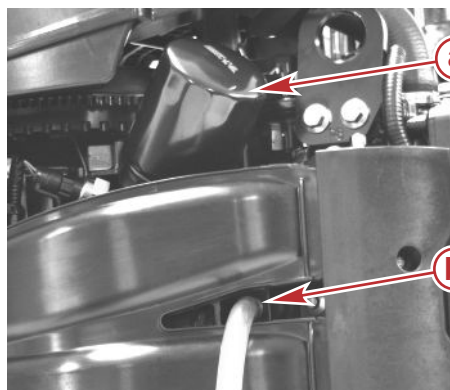

- a** - Oil filter
b - Drain hose

3. Allow the oil in the trough to drain into an appropriate container.
4. Clean the remaining oil from the oil trough and filter mounting base area.
5. Remove the hose and install the plug.

IMPORTANT: Do not use grease on the filter gasket.

6. Apply a film of clean oil to the filter gasket. Install the new filter until the gasket contacts the base and then tighten 3/4 to 1 turn.

MAINTENANCE

OIL FILLING

Remove the oil fill cap and add approximately 6.6 liter (7.0 US qt) of the recommended oil. This will bring the oil level within the operating range.



a - Oil fill cap

b - Dipstick

NOTE: It is not necessary to check the oil level immediately after changing the oil. The engine must be run for a while and then turned off for one hour or longer before checking the oil level. Refer to **Checking Engine Oil Level**.

Checking Engine Oil Level

After the engine oil has been changed, the engine should be run for a few minutes and then turned off, allowing one hour or longer before checking the oil level.

IMPORTANT: For an accurate oil level reading, the engine must be vertical for several minutes before removing the dipstick.

1. Remove the dipstick and observe the area of the five beads.
2. The bead or crosshatch which shows oil furthest from the end is the oil level.



Oil level example

DIPSTICK BEAD OIL LEVEL OVERVIEW

New oil (level) may be difficult to identify which is why the crosshatch between the beads are part of the dipstick assembly. When checking the oil level, if oil is on any of the five oil range beads or four crosshatch, the oil level is within the safe operating range. When the oil level is only on the lowest oil range bead, the operator can add 1.8 Liter (2 US qt) of oil and the level will remain within the safe operating range. When the oil becomes dark from hours of product use, it will be easier to identify the oil level on the dipstick.

MAINTENANCE

IMPORTANT: Repeated removal and insertion of the dipstick to check the oil level will subsequently deposit oil further up the dipstick tube which potentially may cause an error reading the oil level.

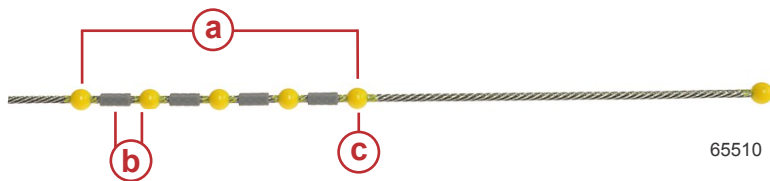

- a** - Safe operating range
- b** - General area after an oil change
- c** - Add 1.8 Liter (2 US qt) of oil

Exhaust Water Strainer Inspection

IMPORTANT: The water strainer is an integral component of the cooling system. It should be inspected every 100 hours of operation or once a year, whichever occurs first.

There are two types of water strainer. Type 1 is an inline pencil-type strainer. Type 2 is a screw-in cross-flow type. Follow the instructions that apply to your engine and water strainer type.

TYPE 1

1. Remove the top cowl. Refer to **Top Cowl Removal and Installation**.
2. Press on the hose lock and pull up to remove the hose from the exhaust water spray inlet assembly.

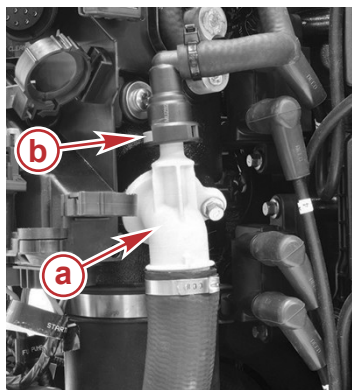

- a** - Exhaust water spray inlet assembly
- b** - Hose lock

MAINTENANCE

3. Remove the strainer from the exhaust water spray inlet assembly.

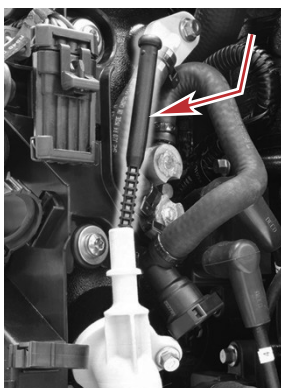

64630

Strainer

4. Inspect the strainer for debris, blockage, or accumulation of mineral deposits. Flush the strainer with fresh water. Use a nylon bristle brush to help remove debris, blockage, or mineral deposits. If the strainer cannot be cleared of debris, blockage, or mineral deposits, or if the strainer is damaged, replace the strainer.



64631

5. Install the strainer into the exhaust water spray inlet assembly.
6. Install the hose onto the exhaust water spray inlet assembly. Verify the hose is secure by pulling up on the hose.

TYPE 2

1. Remove the top cowl. Refer to **Top Cowl Removal and Installation**.
2. Locate the exhaust water strainer (yellow) and turn it counterclockwise to remove it from the water fitting in the upper exhaust tube.

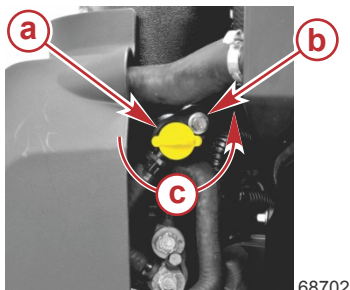

68702

- a - Exhaust water strainer (yellow)
- b - Water fitting in upper exhaust tube
- c - Turn counterclockwise to remove

MAINTENANCE

3. Inspect the strainer for debris, blockage, or accumulation of mineral deposits. Use a nylon bristle brush to help remove debris, blockage, or mineral deposits. If the strainer cannot be cleaned or is damaged, replace the strainer.



68703

4. Insert the clean strainer into the fitting on the engine, and turn it clockwise until tight.

Gearcase Lubricant

GEARCASE LUBRICATION

When adding or changing gearcase lubricant, visually check for the presence of water in the lubricant. If water is present, it may have settled to the bottom and will drain out prior to the lubricant, or it may be mixed with the lubricant, giving it a milky colored appearance. If water is noticed, have the gearcase checked by your dealer. Water in the lubricant may result in premature bearing failure or, in freezing temperatures, will turn to ice and damage the gearcase.

Examine the drained gearcase lubricant for metal particles. A small amount of metal particles indicates normal gear wear. An excessive amount of metal filings or larger particles (chips) may indicate abnormal gear wear and should be checked by an authorized dealer.

RECOMMENDED GEARCASE LUBRICATION

Mercury or Quicksilver High Performance Gear Lubricant.

250R AND 300R REQUIRED GEARCASE LUBRICATION

Extreme Performance Gear Lube - SAE 90

GEARCASE LUBRICANT CAPACITY

NOTE: Gearcase lubricant capacity is approximate.

Gearcase Lubricant Capacity		
122 mm (4.8 in.)*	Right-hand rotation	710 mL (24.0 fl oz)
	Left-hand rotation	810 mL (27.4 fl oz)
137 mm (5.44 in.)	Right-hand rotation	720 mL (24.4 fl oz)
	Left-hand rotation	680 mL (23.0 fl oz)
SeaPro 137 mm (5.44 in.)	Right-hand rotation	980 mL (33.1 fl oz)
	Left-hand rotation	
Torque Master	Right-hand rotation	520 mL (17.5 fl oz)

MAINTENANCE

Gearcase Lubricant Capacity		
Sport Master	Right-hand rotation	620 mL (21.0 fl oz)
	Left-hand rotation	

*Early model 4.8 in. gearcase bearing carriers may have the lubricant level plug located at the 3 o'clock position, requiring a slightly lower volume of gear lubricant.

DRAINING AND FILLING THE GEARCASE - 122 MM (4.8 IN.)

Draining Gearcase

1. Place the outboard in a vertical operating position.
2. Remove the propeller. Refer to **Propeller Replacement**.
3. Place a pan below the gear housing to capture the lubricant.
4. Remove the lubricant level plug and fill/drain plug. Allow a sufficient amount of time for the gearcase to drain. Depending on the ambient air temperature, it may take 30 minutes for the gearcase to completely drain.

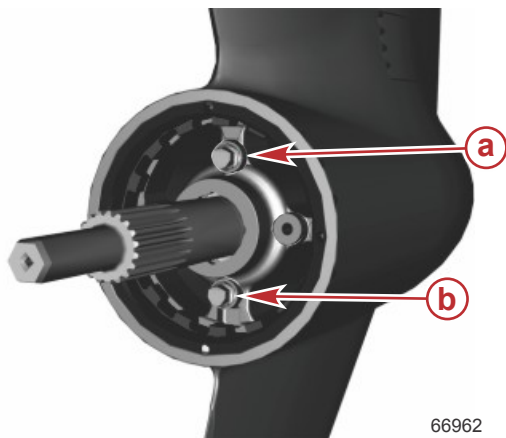

- a - Lubricant level plug
- b - Fill/drain plug

66962

Filling the Gearcase

1. After the gearcase has been drained, fill the gearcase through the fill/drain hole.
2. Add the specified gear lubricant.

IMPORTANT: Replace the sealing washers if damaged.

3. Allow a few minutes for the lubricant level to stabilize in the gearcase before installing the lubricant level plug. Install the lubricant level plug.
4. Remove the tube and install the fill/drain plug.
5. Tighten the plugs to the specified torque.

MAINTENANCE

Description	Nm	lb-in.	lb-ft
Plugs	11.3	100	–

Checking Lubricant Level

1. Place the outboard in a vertical operating position. Allow up to 30 minutes for the lubricant level to stabilize in the gear housing.
2. Remove the lubricant level plug. Verify the sealing washer is not adhered to the bearing carrier. The lubricant should be level with the hole or slowly leak from the hole.

IMPORTANT: Replace the sealing washers if damaged.

3. If the lubricant is not visible at the lubricant level hole, remove the fill/drain plug and add lubricant until it appears at the lubricant level hole.
4. Stop adding lubricant.
5. Remove the lubricant tube and install the fill/drain plug and sealing washer.
6. Tighten the plugs to the specified torque.

Description	Nm	lb-in.	lb-ft
Plugs	11.3	100	–

DRAINING AND FILLING THE GEARCASE - 137 MM (5.4 IN.)

Draining Gearcase

1. Place the outboard in a vertical operating position.
2. Remove the propeller. Refer to **Propeller Replacement**.
3. Place a pan below the gear housing to capture the lubricant.
4. Remove the lubricant level plug and fill/drain plug. Allow a sufficient amount of time for the gearcase to drain. Depending on the ambient air temperature, it may take 30 minutes for the gearcase to completely drain.

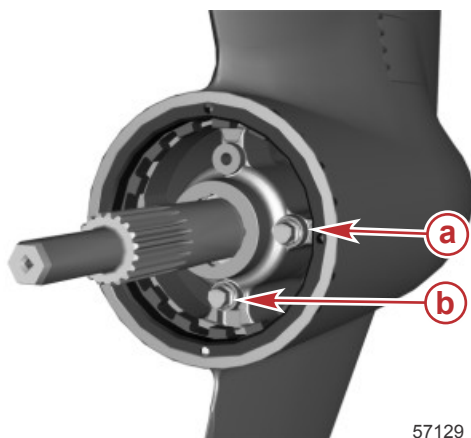

- a - Lubricant level plug
- b - Fill/drain plug

57129

MAINTENANCE

Filling the Gearcase

1. After the gearcase has been drained, fill the gearcase through the fill/drain hole.
2. Add the specified gear lubricant.

IMPORTANT: Replace the sealing washers if damaged.

3. Allow a few minutes for the lubricant level to stabilize in the gearcase before installing the lubricant level plug. Install the lubricant level plug.
4. Remove the tube and install the fill/drain plug.
5. Tighten the plugs to the specified torque.

Description	Nm	lb-in.	lb-ft
Plugs	11.3	100	–

Checking Lubricant Level

1. Place the outboard in a vertical operating position. Allow up to 30 minutes for the lubricant level to stabilize in the gear housing.
2. Remove the lubricant level plug. Verify the sealing washer is not adhered to the bearing carrier. The lubricant should be level with the hole or slowly leak from the hole.

IMPORTANT: Replace the sealing washers if damaged.

3. If the lubricant is not visible at the lubricant level hole, remove the fill/drain plug and add lubricant until it appears at the lubricant level hole.
4. Stop adding lubricant.
5. Remove the lubricant tube and install the fill/drain plug and sealing washer.
6. Tighten the plugs to the specified torque.

Description	Nm	lb-in.	lb-ft
Plugs	11.3	100	–

DRAINING AND FILLING THE GEARCASE SEAPRO MODELS

1. Tilt the engine so the leading edge of the skeg is level when horizontal, or the engine can be tilted full up.
2. Place a pan below the gear housing to capture the lubricant.

MAINTENANCE

3. Remove the lubricant level plug and fill/drain plug. Allow a sufficient amount of time for the gearcase to drain. Depending on the ambient air temperature, it may take 30 minutes for the gearcase to completely drain.

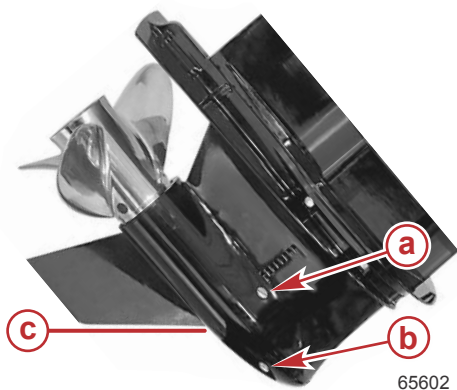

- a - Lubricant level plug
- b - Fill/drain plug
- c - Leading edge of skag is level

Filling the Gearcase

1. After the gearcase has been drained, fill the gearcase with the specified gear lubricant through the fill/drain hole.

IMPORTANT: Replace the sealing washers if damaged.

2. The lubricant must flow out of the lubricant level hole without air bubbles.
3. Allow a few minutes for the lubricant level to stabilize in the gearcase before installing the lubricant level plug. Install the lubricant level plug.
4. Remove the tube and install the fill/drain plug.
5. Tighten the plugs to the specified torque.

Description	Nm	lb-in.	lb-ft
Plugs	11.3	100	-

Checking Lubricant Level

1. Tilt the engine so the leading edge of the skag is level when horizontal. Allow up to 30 minutes for the lubricant level to stabilize in the gear housing.
2. Remove the lubricant level plug. Do not lose the sealing washer. The lubricant should be level with the hole or slowly leak from the hole.

IMPORTANT: Replace the sealing washers if damaged.

3. If the lubricant is not visible at the lubricant level hole, remove the fill/drain plug and add lubricant until it appears at the lubricant level hole.
4. Install the lubricant level plug.
5. Remove the lubricant tube and install the fill/drain plug and sealing washer.
6. Tighten the plugs to the specified torque.

MAINTENANCE

Description	Nm	lb-in.	lb-ft
Plugs	11.3	100	-

STORAGE

Storage Preparation

The major consideration in preparing your outboard for storage is to protect it from rust, corrosion, and damage caused by freezing of trapped water.

The following storage procedures should be followed to prepare your outboard for out of season storage or prolonged storage (two months or longer).

NOTICE

Without sufficient cooling water, the engine, the water pump, and other components will overheat and suffer damage. Provide a sufficient supply of water to the water inlets during operation.



FUEL SYSTEM

IMPORTANT: Gasoline containing alcohol (ethanol or methanol) can cause a formation of acid during storage and can damage the fuel system. If the gasoline being used contains alcohol, it is advisable to drain as much of the remaining gasoline as possible from the fuel tank, remote fuel line, and engine fuel system.

IMPORTANT: This outboard is equipped with a closed fuel system when the engine is not running. With this closed system, fuel within the engine's fuel system, other than the fuel tank, will remain stable during normal storage periods without the addition of fuel treatment stabilizers.



Fill the fuel tank and engine fuel system with treated (stabilized) fuel to help prevent formation of varnish and gum. Proceed with the following instructions.

- Portable fuel tank - Pour the required amount of Quickstor Fuel Stabilizer (follow instructions on container) into fuel tank. Tip fuel tank back and forth to mix stabilizer with the fuel.
- Permanently installed fuel tank - Pour the required amount of Quickstor Fuel Stabilizer (follow instructions on container) into a separate container and mix with approximately one liter (one quart) of gasoline. Pour this mixture into fuel tank.

Tube Ref No.	Description	Where Used	Part No.
 124 	Quickstor Fuel Stabilizer	Fuel tank	92-8M0047932

Protecting External Outboard Components

- Touch up any paint nicks. See your dealer for touch-up paint.
- Spray Quicksilver or Mercury Precision Lubricants Corrosion Guard on external metal surfaces (except corrosion control anodes).

Tube Ref No.	Description	Where Used	Part No.
 120 	Corrosion Guard	External metal surfaces	92-802878 55

STORAGE

Protecting Internal Engine Components

IMPORTANT: Refer to Maintenance - Spark Plug Inspection and Replacement for correct procedure for removing spark plugs.

- Remove the high tension spark plug leads and spark plugs.
- Spray approximately 30 ml (1 fl oz) of Storage Seal Rust Inhibitor into each spark plug hole.

Tube Ref No.	Description	Where Used	Part No.
 119	Storage Seal Rust Inhibitor	Spark plug holes	92-858081K03

- Actuate key/push button start switch to crank the engine through one start cycle, which will distribute the storage seal throughout the cylinders.
- Install spark plugs and the high tension spark plug leads.

Gearcase

- Drain and refill the gearcase lubricant. Refer to **Gearcase Lubrication**.

Positioning Outboard for Storage

Store outboard in an upright (vertical) position to allow water to drain out of the outboard.

NOTICE

Storing the outboard in a tilted position can damage the outboard. Water trapped in the cooling passages or rain water collected in the propeller exhaust outlet in the gearcase can freeze. Store the outboard in the full down position.

Battery Storage

- Follow the battery manufacturer's instructions for storage and charging.
- Remove the battery from the boat and check water level. Charge if necessary.
- Store the battery in a cool, dry place.
- Periodically check the water level and charge the battery during storage.

TROUBLESHOOTING

Starter Motor Will Not Crank the Engine

POSSIBLE CAUSES

- Lanyard stop switch not in RUN position.
- Open 20-amp fuse. Check the power driver fuse. Refer to **Maintenance** section.
- Outboard is not shifted to neutral position.
- Weak battery or battery connections are loose or corroded.
- Ignition key switch failure.
- Wiring or electrical connection faulty.
- Starter motor solenoid or starter relay failure.

Engine Will Not Start

POSSIBLE CAUSES

- Incorrect starting procedure. Refer to **Operation** section.
- Old or contaminated gasoline.
- Fuel is not reaching the engine.
 - Fuel tank is empty.
 - Fuel tank vent not open or restricted.
 - Fuel line is disconnected or kinked.
 - Fuel filter is obstructed. Refer to **Maintenance** section.
 - Fuel pump failure.
 - Fuel tank filter obstructed.
- Ignition system component failure.
- Spark plugs fouled or defective. Refer to **Maintenance** section.

Engine Runs Erratically

POSSIBLE CAUSES

- Overheating - Warning horn not working.
- Low oil pressure. Check oil level.
- Spark plugs fouled or defective. Refer to **Maintenance** section.
- Incorrect setup and adjustments.
- Fuel is being restricted to the engine.
 - a. Engine fuel filter is obstructed. Refer to **Maintenance** section.
 - b. Fuel tank filter obstructed.
 - c. Stuck anti-siphon valve located on permanently built-in type fuel tanks.
 - d. Fuel line is kinked or pinched.
- Fuel pump failure.

TROUBLESHOOTING

- Ignition system component failure.

Performance Loss

POSSIBLE CAUSES

- Overheating - Warning horn not working.
- Low oil pressure. Check oil level.
- Throttle not opening fully.
- Damaged propeller or improper propeller size.
- Incorrect engine timing, adjustment, or setup.
- Boat overloaded or load improperly distributed.
- Excessive water in bilge.
- Boat bottom is dirty or damaged.

Battery Will Not Hold Charge

POSSIBLE CAUSES

- Battery connections are loose or corroded.
- Low electrolyte level in battery.
- Worn out or inefficient battery.
- Excessive use of electrical accessories.
- Defective rectifier, alternator, or voltage regulator.
- Open circuit in the alternator output wire (fused link).

OWNER SERVICE ASSISTANCE

Service Assistance

LOCAL REPAIR SERVICE

If you need service for your Mercury-outboard-powered boat, take it to your authorized dealer. Only authorized dealers specialize in Mercury products and have factory-trained mechanics, special tools and equipment, and genuine Quicksilver parts and accessories to properly service your engine.

NOTE: *Quicksilver parts and accessories are engineered and built by Mercury Marine specifically for your power package.*

SERVICE AWAY FROM HOME

If you are away from your local dealer and the need arises for service, contact the nearest authorized dealer. If, for any reason, you cannot obtain service, contact the nearest Regional Service Center. Outside the United States and Canada, contact the nearest Marine Power International Service Center.

STOLEN POWER PACKAGE

If your power package is stolen, immediately advise the local authorities and Mercury Marine of the model and serial numbers and to whom the recovery is to be reported. This information is maintained in a database at Mercury Marine to aid authorities and dealers in the recovery of stolen power packages.

ATTENTION REQUIRED AFTER SUBMERSION

1. Before recovery, contact an authorized Mercury dealer.
2. After recovery, immediate service by an authorized Mercury dealer is required to reduce the possibility of serious engine damage.

REPLACEMENT SERVICE PARTS

WARNING

Avoid fire or explosion hazard. Electrical, ignition, and fuel system components on Mercury Marine products comply with federal and international standards to minimize risk of fire or explosion. Do not use replacement electrical or fuel system components that do not comply with these standards. When servicing the electrical and fuel systems, properly install and tighten all components.

Marine engines are expected to operate at or near full throttle for most of their lives. They are also expected to operate in both fresh and saltwater environments. These conditions require numerous special parts.

PARTS AND ACCESSORIES INQUIRIES

Direct any inquiries concerning genuine Mercury Precision Parts® or Quicksilver Marine Parts and Accessories® to a local authorized dealer. Dealers have the proper systems to order parts and accessories, if they are not in stock. **Engine model** and **serial number** are required to order correct parts.

OWNER SERVICE ASSISTANCE

RESOLVING A PROBLEM

Satisfaction with your Mercury product is important to your dealer and to us. If you ever have a problem, question or concern about your power package, contact your dealer or any authorized Mercury dealership. If you need additional assistance:

1. Talk with the dealership's sales manager or service manager.
2. If your question, concern, or problem cannot be resolved by your dealership, please contact the Mercury Marine Service Office for assistance. Mercury Marine will work with you and your dealership to resolve all problems.

The following information will be needed by the Customer Service:

- Your name and address
- Your daytime telephone number
- The model and serial numbers of your power package
- The name and address of your dealership
- The nature of the problem

CONTACT INFORMATION FOR MERCURY MARINE CUSTOMER SERVICE

For assistance, call, fax, or write to the geographic office in your area. Please include your daytime telephone number with mail and fax correspondence.

United States, Canada		
Telephone	English +1 920 929 5040 Français +1 905 636 4751	Mercury Marine W6250 Pioneer Road P.O. Box 1939 Fond du Lac, WI 54936-1939
Fax	English +1 920 929 5893 Français +1 905 636 1704	
Website	www.mercurymarine.com	

Australia, Pacific		
Telephone	+61 3 9791 5822	Brunswick Asia Pacific Group 41-71 Bessemer Drive Dandenong South, Victoria 3175 Australia
Fax	+61 3 9706 7228	

Europe, Middle East, Africa		
Telephone	+32 87 32 32 11	Brunswick Marine Europe Parc Industriel de Petit-Rechain B-4800 Verviers, Belgium
Fax	+32 87 31 19 65	

OWNER SERVICE ASSISTANCE

Mexico, Central America, South America, Caribbean		
Telephone	+1 954 744 3500	Mercury Marine 11650 Interchange Circle North Miramar, FL 33025 U.S.A.
Fax	+1 954 744 3535	

Asia, Singapore, Japan		
Telephone	+65 68058100	Mercury Marine Singapore Pte Ltd 11 Changi South Street 3, #01-02 Singapore, 486122
Fax	+65 68058138	

Ordering Literature

Before ordering literature, have the following information about your power package available:

Model		Serial Number	
Horsepower		Year	

UNITED STATES AND CANADA

For additional literature for your Mercury Marine power package, contact your nearest Mercury Marine dealer or contact:

Mercury Marine		
Telephone	Fax	Mail
(920) 929-5110	(920) 929-4894	Mercury Marine Attn: Publications Department P.O. Box 1939 Fond du Lac, WI 54936-1939

OUTSIDE THE UNITED STATES AND CANADA

Contact your nearest Mercury Marine authorized service center to order additional literature that is available for your particular power package.

Submit the following order form with payment to:	Mercury Marine Attn: Publications Department W6250 Pioneer Road P.O. Box 1939 Fond du Lac, WI 54936-1939
Ship To: (Copy this form and print or type—This is your shipping label)	
Name	
Address	
City, State, Province	
ZIP or postal code	
Country	

OWNER SERVICE ASSISTANCE

Quantity	Item	Stock Number	Price	Total
			.	.
			.	.
			.	.
			.	.
			.	.
			Total Due	.

